

Ergebnis: **393** (412.6)
 Serien: 100 97 99 97
 Zähler: 33 7 0 0 0 0 0 0 0 0
 Innenzehner: 30
 weiteste: 427 (37), 413 (14), 358 (32)
 beste Teiler 16.0 (8.) 23.5 (9.) 53.0 (28.)
 Trefferlage 0.03 mm rechts, 0.10 mm tief
 Streuwert 1.32, horizontal: 1.67, vertikal: 0.84

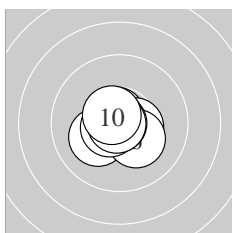

Serie 1:
 10.2 * 10.7 * 10.7 * 10.5 * 10.7 *
 10.3 * 10.6 * 10.9 * 10.9 * 10.6 *
 beste Teiler 16.0 (8.) 23.5 (9.) 59.9 (2.)
 Trefferlage 0.22 mm links, 0.09 mm tief
 Streuwert 0.76, horizontal: 0.86, vertikal: 0.64

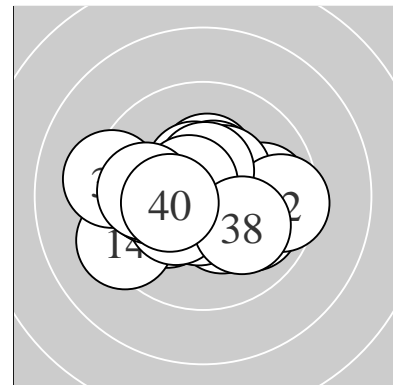
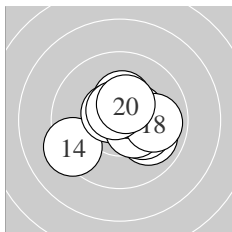

Serie 2:
 10.3 * 9.9 ↘ 10.4 * 9.3 ↙ 10.6 *
 10.2 * 10.4 * 9.9 → 10.6 * 10.4 *
 beste Teiler 82.3 (19.) 89.4 (15.) 129.4 (17.)
 Trefferlage 0.49 mm rechts, 0.03 mm tief
 Streuwert 1.50, horizontal: 1.79, vertikal: 1.14

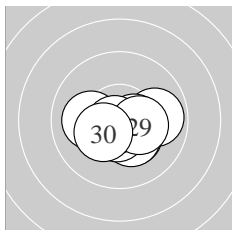

Serie 3:
 9.9 → 10.5 * 10.5 * 10.3 * 10.1 ←
 10.3 * 10.6 * 10.7 * 10.3 * 10.3 *
 beste Teiler 53.0 (28.) 96.8 (27.) 113.7 (22.)
 Trefferlage 0.42 mm rechts, 0.58 mm tief
 Streuwert 1.07, horizontal: 1.43, vertikal: 0.51

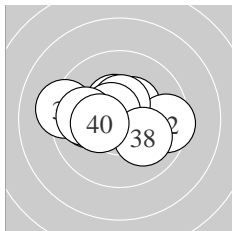

Serie 4:
 10.4 * 9.5 → 10.5 * 10.5 * 10.0 ←
 10.6 * 9.2 ← 10.1 ↘ 9.9 ← 10.3 *
 beste Teiler 84.3 (36.) 115.4 (34.) 124.5 (33.)
 Trefferlage 0.53 mm links, 0.29 mm hoch
 Streuwert 1.71, horizontal: 2.28, vertikal: 0.81

Unterschrift des Schützen

Meyton Elektronik

Ergebnis: **394** (414.0)
 Serien: 98 98 98 100
 Zähler: 34 6 0 0 0 0 0 0 0 0
 Innenzehner: 28
 weiteste: 297 (26), 294 (14), 290 (3)
 beste Teiler 21.2 (30.) 22.8 (9.) 42.0 (5.)
 Trefferlage 0.31 mm rechts, 0.25 mm tief
 Streuwert 1.19, horizontal: 1.43, vertikal: 0.89

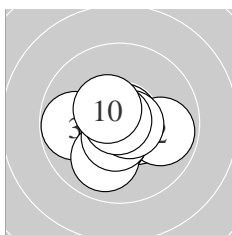
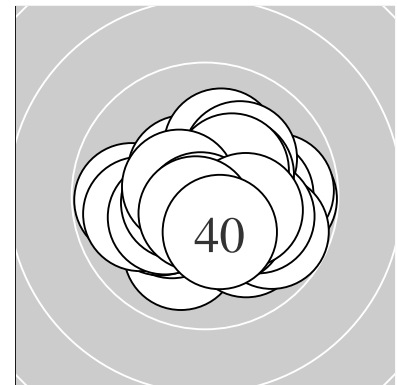

Serie 1:
 10.5 * 9.9 → 9.8 ← 10.5 * 10.8 *
 10.0 ↙ 10.6 * 10.7 * 10.9 * 10.5 *
 beste Teiler 22.8 (9.) 42.0 (5.) 65.4 (8.)
 Trefferlage 0.07 mm links, 0.41 mm tief
 Streuwert 1.21, horizontal: 1.46, vertikal: 0.88

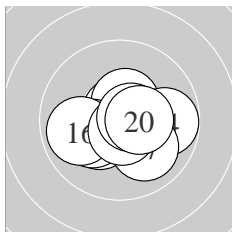

Serie 2:
 10.7 * 10.5 * 10.3 * 9.8 → 10.2 *
 9.9 ← 10.0 ↘ 10.7 * 10.6 * 10.4 *
 beste Teiler 56.9 (11.) 73.2 (18.) 77.1 (19.)
 Trefferlage 0.13 mm rechts, 0.32 mm tief
 Streuwert 1.31, horizontal: 1.66, vertikal: 0.84

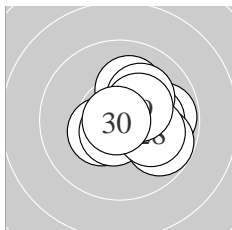

Serie 3:
 10.4 * 9.8 → 10.6 * 10.1 → 10.1 ↑
 9.8 ↘ 10.1 ↗ 10.1 → 10.4 * 10.9 *
 beste Teiler 21.2 (30.) 86.3 (23.) 139.8 (21.)
 Trefferlage 1.09 mm rechts, 0.07 mm hoch
 Streuwert 1.23, horizontal: 1.36, vertikal: 1.08

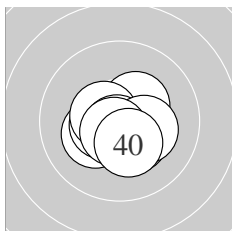

Serie 4:
 10.2 * 10.5 * 10.5 * 10.4 * 10.4 *
 10.5 * 10.7 * 10.3 * 10.6 * 10.3 *
 beste Teiler 55.9 (37.) 78.2 (39.) 108.1 (36.)
 Trefferlage 0.10 mm rechts, 0.36 mm tief
 Streuwert 0.94, horizontal: 1.09, vertikal: 0.75

Unterschrift des Schützen

Meyton Elektronik

Ergebnis: **395** (414.9)
 Serien: 99 98 98 100
 Zähler: 35 5 0 0 0 0 0 0 0 0
 Innenzehner: 28
 weiteste: 381 (4), 293 (30), 292 (26)
 beste Teiler 30.4 (8.) 34.4 (21.) 36.3 (10.)
 Trefferlage 0.10 mm links, 0.21 mm tief
 Streuwert 1.20, horizontal: 1.47, vertikal: 0.85

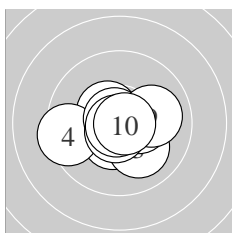
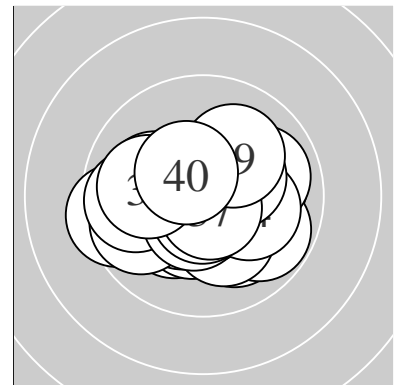

Serie 1:
 10.5 * 10.5 * 10.1 ↘ 9.4 ← 10.4 *
 10.8 * 10.7 * 10.8 * 10.0 → 10.8 *
 beste Teiler 30.4 (8.) 36.3 (10.) 49.6 (6.)
 Trefferlage 0.05 mm links, 0.28 mm tief
 Streuwert 1.29, horizontal: 1.64, vertikal: 0.78

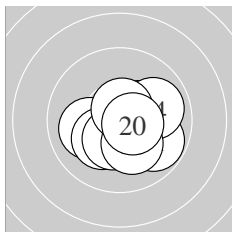

Serie 2:
 9.8 ↘ 10.3 * 10.7 * 9.9 → 10.1 ←
 10.2 * 10.4 * 10.2 * 10.6 * 10.6 *
 beste Teiler 69.1 (13.) 82.0 (19.) 98.7 (20.)
 Trefferlage 0.42 mm rechts, 0.51 mm tief
 Streuwert 1.27, horizontal: 1.51, vertikal: 0.98

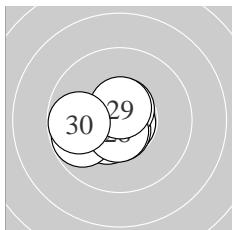

Serie 3:
 10.8 * 10.4 * 10.3 * 10.8 * 10.7 *
 9.8 ← 10.6 * 10.6 * 10.6 * 9.8 ←
 beste Teiler 34.4 (21.) 41.1 (24.) 73.0 (25.)
 Trefferlage 0.78 mm links, 0.26 mm tief
 Streuwert 0.99, horizontal: 1.21, vertikal: 0.70

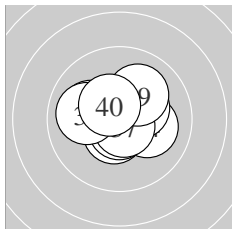

Serie 4:
 10.1 ← 10.5 * 10.7 * 10.1 → 10.7 *
 10.3 * 10.7 * 10.0 ← 10.1 ↗ 10.5 *
 beste Teiler 60.5 (37.) 70.0 (35.) 74.4 (33.)
 Trefferlage 0.00 mm , 0.20 mm hoch
 Streuwert 1.20, horizontal: 1.45, vertikal: 0.88

Unterschrift des Schützen

Meyton Elektronik

Ergebnis: **411.4** (389)
 Serien: 101.5 102.7 104.1 103.1
 Zähler: 29 11 0 0 0 0 0 0 0 0
 Innenzehner: 28
 weiteste: 429 (7), 424 (5), 397 (25)
 beste Teiler 31.0 (23.) 33.0 (28.) 41.6 (3.)
 Trefferlage 0.83 mm rechts, 0.03 mm tief
 Streuwert 1.36, horizontal: 1.83, vertikal: 0.57

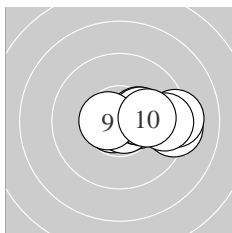
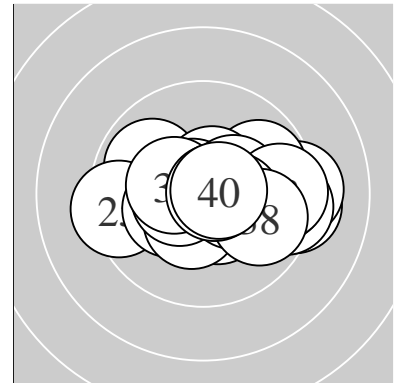

Serie 1:
 10.7 * 10.5 * 10.8 * 10.4 * 9.3 →
 10.3 * 9.2 → 9.6 → 10.6 * 10.1 →
 beste Teiler 41.6 (3.) 53.8 (1.) 91.0 (9.)
 Trefferlage 1.72 mm rechts, 0.03 mm hoch
 Streuwert 1.31, horizontal: 1.83, vertikal: 0.30

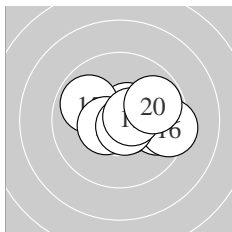

Serie 2:
 10.6 * 9.8 → 10.8 * 10.6 * 9.9 ↘
 9.4 → 10.5 * 10.7 * 10.6 * 9.8 →
 beste Teiler 42.6 (13.) 61.0 (18.) 76.4 (11.)
 Trefferlage 0.82 mm rechts, 0.13 mm hoch
 Streuwert 1.41, horizontal: 1.87, vertikal: 0.71

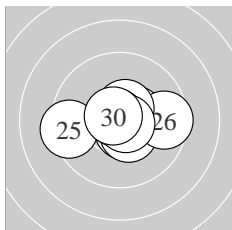

Serie 3:
 10.4 * 10.6 * 10.8 * 10.5 * 9.4 ←
 9.6 → 10.6 * 10.8 * 10.7 * 10.7 *
 beste Teiler 31.0 (23.) 33.0 (28.) 55.0 (29.)
 Trefferlage 0.19 mm rechts, 0.07 mm tief
 Streuwert 1.35, horizontal: 1.81, vertikal: 0.61

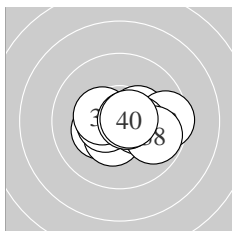

Serie 4:
 10.4 * 10.3 * 9.5 → 10.4 * 10.4 *
 10.5 * 10.4 * 9.8 ↘ 10.7 * 10.7 *
 beste Teiler 53.3 (39.) 74.7 (40.) 110.3 (36.)
 Trefferlage 0.58 mm rechts, 0.23 mm tief
 Streuwert 1.29, horizontal: 1.72, vertikal: 0.60

Unterschrift des Schützen

Meyton Elektronik

Ergebnis: **392** (411.2)
 Serien: 96 96 100 100
 Zähler: 33 6 1 0 0 0 0 0 0
 Innenzehner: 27
 weiteste: 508 (5), 457 (16), 355 (19)
 beste Teiler 24.8 (8.) 42.5 (9.) 45.3 (33.)
 Trefferlage 0.18 mm rechts, 0.21 mm tief
 Streuwert 1.41, horizontal: 1.79, vertikal: 0.90

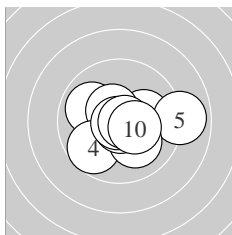
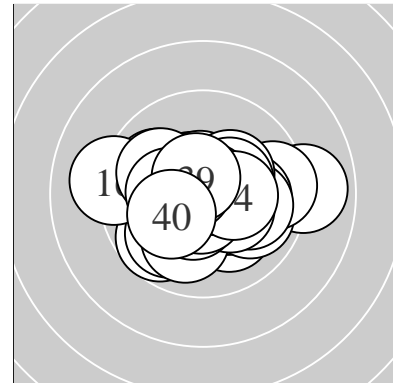

Serie 1:
 9.9 ↖ 10.1 → 10.5 * 9.7 ✓ 8.9 →
 10.1 ↘ 10.8 * 10.9 * 10.8 * 10.4 *
 beste Teiler 24.8 (8.) 42.5 (9.) 47.6 (7.)
 Trefferlage 0.48 mm rechts, 0.24 mm tief
 Streuwert 1.69, horizontal: 2.15, vertikal: 1.04

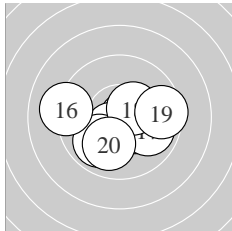

Serie 2:
 10.7 * 10.5 * 9.9 ✓ 10.3 * 10.4 *
 9.1 ← 9.9 ↘ 10.4 * 9.5 → 10.0 ✓
 beste Teiler 56.4 (11.) 118.9 (12.) 135.3 (18.)
 Trefferlage 0.24 mm rechts, 0.59 mm tief
 Streuwert 1.78, horizontal: 2.29, vertikal: 1.04

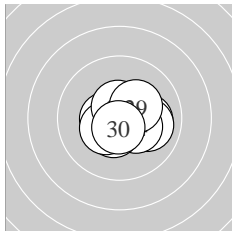

Serie 3:
 10.7 * 10.1 → 10.0 → 10.3 * 10.5 *
 10.5 * 10.4 * 10.6 * 10.3 * 10.6 *
 beste Teiler 63.0 (21.) 78.7 (30.) 96.1 (28.)
 Trefferlage 0.40 mm rechts, 0.28 mm tief
 Streuwert 1.06, horizontal: 1.32, vertikal: 0.73

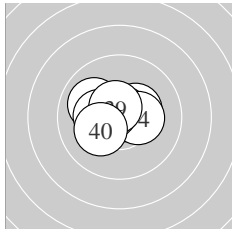

Serie 4:
 10.7 * 10.4 * 10.8 * 10.3 * 10.6 *
 10.5 * 10.0 ↖ 10.3 * 10.6 * 10.2 *
 beste Teiler 45.3 (33.) 52.8 (31.) 85.4 (35.)
 Trefferlage 0.39 mm links, 0.28 mm hoch
 Streuwert 1.00, horizontal: 1.29, vertikal: 0.58

Unterschrift des Schützen

Meyton Elektronik

Ergebnis: **391** (412.1)
 Serien: 99 97 98 97
 Zähler: 31 9 0 0 0 0 0 0 0 0
 Innenzehner: 29
 weiteste: 497 (11), 429 (37), 329 (35)
 beste Teiler 24.0 (33.) 24.3 (8.) 40.5 (31.)
 Trefferlage 0.01 mm links, 0.15 mm tief
 Streuwert 1.39, horizontal: 1.67, vertikal: 1.03

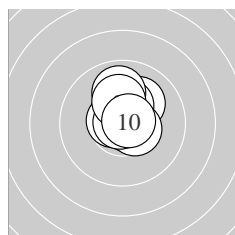
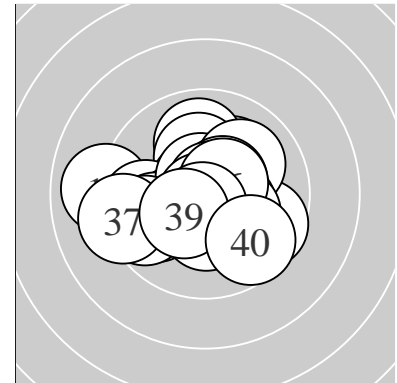

Serie 1:
 10.1 ↗ 10.3 * 10.7 * 10.6 * 10.6 *
 9.9 ↑ 10.5 * 10.9 * 10.2 * 10.7 *
 beste Teiler 24.3 (8.) 51.2 (3.) 53.8 (10.)
 Trefferlage 0.14 mm rechts, 0.79 mm hoch
 Streuwert 0.86, horizontal: 0.70, vertikal: 1.01

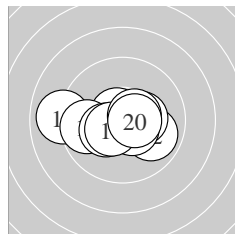

Serie 2:
 9.0 ← 9.9 ↘ 10.3 * 10.7 * 10.5 *
 9.7 ← 10.3 * 10.5 * 10.5 * 10.5 *
 beste Teiler 65.7 (14.) 101.1 (20.) 104.4 (19.)
 Trefferlage 0.40 mm links, 0.28 mm tief
 Streuwert 1.64, horizontal: 2.25, vertikal: 0.58

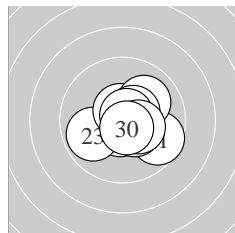

Serie 3:
 9.6 ↘ 10.6 * 9.9 ↙ 10.6 * 10.0 ↗
 10.5 * 10.4 * 10.7 * 10.4 * 10.7 *
 beste Teiler 51.0 (28.) 73.3 (30.) 83.1 (22.)
 Trefferlage 0.57 mm rechts, 0.21 mm tief
 Streuwert 1.22, horizontal: 1.43, vertikal: 0.98

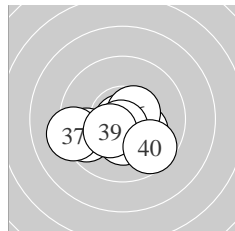

Serie 4:
 10.8 * 10.3 * 10.9 * 10.2 * 9.6 ↙
 10.5 * 9.2 ← 10.7 * 10.4 * 9.7 ↘
 beste Teiler 24.0 (33.) 40.5 (31.) 67.4 (38.)
 Trefferlage 0.37 mm links, 0.91 mm tief
 Streuwert 1.49, horizontal: 1.95, vertikal: 0.79

Unterschrift des Schützen

Meyton Elektronik

Ergebnis: **398** (415.5)
 Serien: 100 100 98 100
 Zähler: 38 2 0 0 0 0 0 0 0 0
 Innenzehner: 33
 weiteste: 441 (21), 287 (27), 248 (17)
 beste Teiler 27.0 (10.) 28.4 (8.) 36.2 (14.)
 Trefferlage 0.44 mm rechts, 0.14 mm tief
 Streuwert 1.12, horizontal: 1.27, vertikal: 0.94

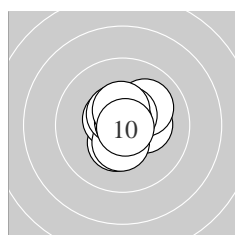
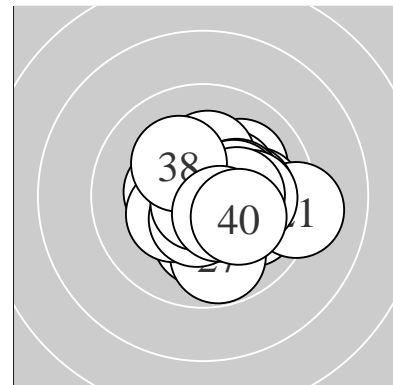

Serie 1:
 10.4 * 10.3 * 10.1 ↗ 10.6 * 10.6 *
 10.4 * 10.5 * 10.8 * 10.5 * 10.8 *
 beste Teiler 27.0 (10.) 28.4 (8.) 90.0 (5.)
 Trefferlage 0.18 mm rechts, 0.21 mm hoch
 Streuwert 0.92, horizontal: 0.89, vertikal: 0.95

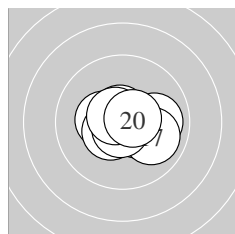

Serie 2:
 10.0 → 10.7 * 10.4 * 10.8 * 10.4 *
 10.5 * 10.0 ↘ 10.7 * 10.7 * 10.6 *
 beste Teiler 36.2 (14.) 54.7 (18.) 68.3 (12.)
 Trefferlage 0.30 mm rechts, 0.14 mm tief
 Streuwert 1.02, horizontal: 1.32, vertikal: 0.57

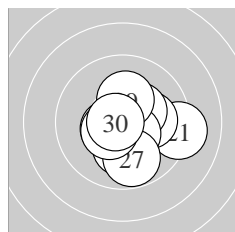

Serie 3:
 9.2 → 10.1 → 10.2 * 10.4 * 10.5 *
 10.5 * 9.8 ↓ 10.5 * 10.2 * 10.7 *
 beste Teiler 57.0 (30.) 117.2 (26.) 118.5 (25.)
 Trefferlage 0.65 mm rechts, 0.47 mm tief
 Streuwert 1.48, horizontal: 1.64, vertikal: 1.30

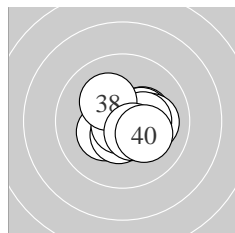

Serie 4:
 10.3 * 10.5 * 10.3 * 10.4 * 10.8 *
 10.1 → 10.3 * 10.2 * 10.5 * 10.2 *
 beste Teiler 38.8 (35.) 112.0 (32.) 115.3 (39.)
 Trefferlage 0.62 mm rechts, 0.18 mm tief
 Streuwert 1.07, horizontal: 1.27, vertikal: 0.81

Unterschrift des Schützen

Meyton Elektronik

Ergebnis: **395** (413.8)
 Serien: 100 98 97 100
 Zähler: 35 5 0 0 0 0 0 0 0 0
 Innenzehner: 30
 weiteste: 473 (24), 395 (20), 352 (13)
 beste Teiler 28.0 (14.) 32.0 (27.) 39.5 (10.)
 Trefferlage 0.20 mm rechts, 0.00 mm
 Streuwert 1.31, horizontal: 1.62, vertikal: 0.89

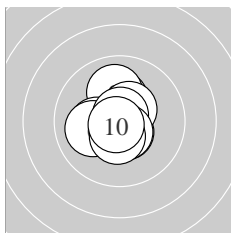
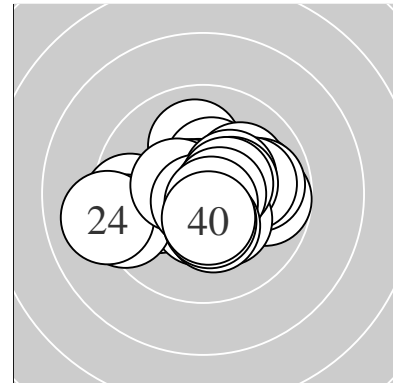

Serie 1:
 10.2 * 10.0 ↑ 10.2 * 10.6 * 10.5 *
 10.1 ← 10.8 * 10.6 * 10.5 * 10.8 *
 beste Teiler 39.5 (10.) 48.5 (7.) 96.6 (8.)
 Trefferlage 0.30 mm links, 0.13 mm hoch
 Streuwert 1.08, horizontal: 0.96, vertikal: 1.20

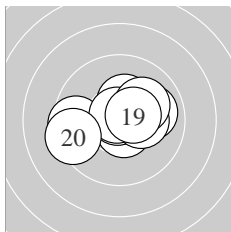

Serie 2:
 10.6 * 10.4 * 9.5 ← 10.8 * 10.0 →
 10.3 * 10.8 * 10.1 ↗ 10.5 * 9.4 ←
 beste Teiler 28.0 (14.) 45.1 (17.) 83.2 (11.)
 Trefferlage 0.01 mm rechts, 0.18 mm hoch
 Streuwert 1.60, horizontal: 2.10, vertikal: 0.84

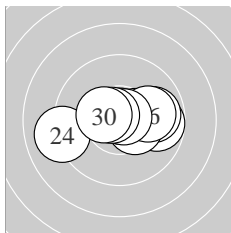

Serie 3:
 9.8 → 9.9 → 10.4 * 9.1 ← 10.4 *
 10.0 → 10.8 * 10.8 * 10.7 * 10.4 *
 beste Teiler 32.0 (27.) 42.8 (28.) 75.8 (29.)
 Trefferlage 0.42 mm rechts, 0.07 mm hoch
 Streuwert 1.64, horizontal: 2.25, vertikal: 0.54

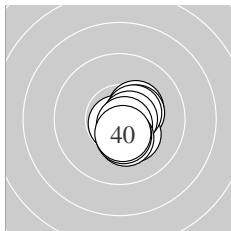

Serie 4:
 10.3 * 10.8 * 10.4 * 10.3 * 10.5 *
 10.6 * 10.7 * 10.3 * 10.4 * 10.5 *
 beste Teiler 44.2 (32.) 59.5 (37.) 79.0 (36.)
 Trefferlage 0.68 mm rechts, 0.42 mm tief
 Streuwert 0.72, horizontal: 0.53, vertikal: 0.86

Unterschrift des Schützen

Meyton Elektronik