

Ergebnis: **377** (395.9)  
 Serien: 94 93 95 95  
 Zähler: 19 19 2 0 0 0 0 0 0 0  
 Innenzehner: 14  
 weiteste: 617 (32), 616 (20), 438 (21)  
 beste Teiler 44.4 (40.) 47.0 (16.) 49.6 (35.)  
 Trefferlage 1.81 mm rechts, 0.03 mm tief  
 Streuwert 1.69, horizontal: 1.96, vertikal: 1.36

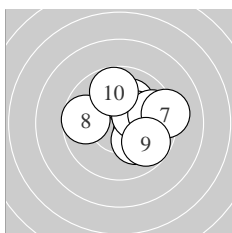

Serie 1:  
 10.1 ↗ 9.4 → 10.2 \* 10.1 ↘ 10.3 \*  
 9.7 → 9.2 → 9.7 ← 9.8 ↘ 9.8 ↑  
 beste Teiler 167.7 (5.) 183.8 (3.) 208.8 (1.)  
 Trefferlage 1.53 mm rechts, 0.41 mm hoch  
 Streuwert 1.83, horizontal: 2.14, vertikal: 1.44

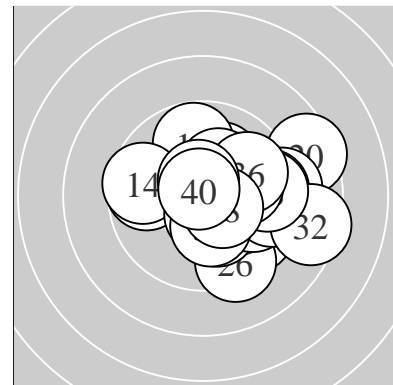
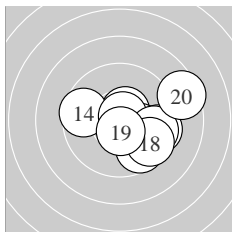

Serie 2:  
 10.6 \* 10.2 \* 9.5 → 9.6 ← 9.7 ↘  
 10.8 \* 9.6 → 9.6 ↘ 10.5 \* 8.5 →  
 beste Teiler 47.0 (16.) 98.7 (11.) 102.4 (19.)  
 Trefferlage 1.64 mm rechts, 0.38 mm tief  
 Streuwert 2.02, horizontal: 2.45, vertikal: 1.46

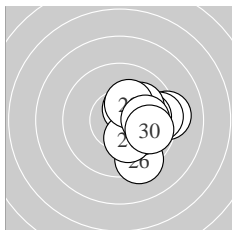

Serie 3:  
 9.2 → 9.5 → 9.9 → 10.5 \* 10.1 ↗  
 9.3 ↘ 10.2 \* 10.3 \* 10.0 → 9.8 →  
 beste Teiler 121.7 (24.) 172.4 (28.) 184.3 (27.)  
 Trefferlage 2.16 mm rechts, 0.12 mm tief  
 Streuwert 1.40, horizontal: 1.23, vertikal: 1.56

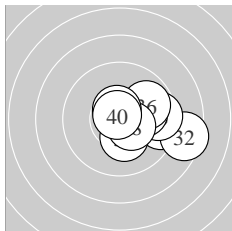

Serie 4:  
 9.4 → 8.5 → 9.5 → 10.0 → 10.8 \*  
 9.8 → 10.3 \* 10.5 \* 10.6 \* 10.8 \*  
 beste Teiler 44.4 (40.) 49.6 (35.) 89.8 (39.)  
 Trefferlage 1.92 mm rechts, 0.06 mm tief  
 Streuwert 1.62, horizontal: 2.06, vertikal: 1.01

Unterschrift des Schützen

Meyton Elektronik

Ergebnis:	<b>378</b>	(395.5)
Serien:	94 96 93 95	
Zähler:	20 18 2 0 0 0 0 0 0 0	
Innenzehner:	17	
weiteste:	505 (24), 505 (31), 496 (25)	
beste Teiler	53.2 (38.) 86.0 (4.) 101.0 (27.)	
Trefferlage	1.72 mm rechts, 0.13 mm hoch	
Streuwert	1.73, horizontal: 2.10, vertikal: 1.28	

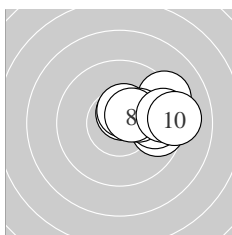
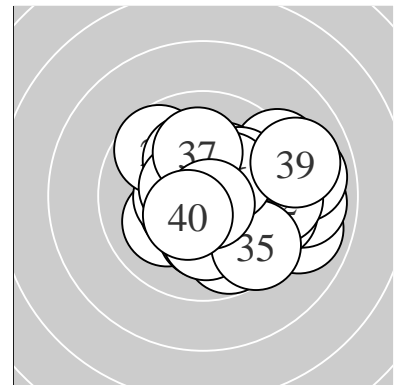

Serie 1:					
	9.3 →	9.7 →	9.2 ↗	10.6 *	10.5 *
	9.8 →	10.3 *	10.5 *	9.5 →	9.1 →
beste Teiler	86.0 (4.) 110.6 (5.) 120.9 (8.)				
Trefferlage	2.54 mm rechts, 0.63 mm hoch				
Streuwert	1.24, horizontal: 1.62, vertikal: 0.68				

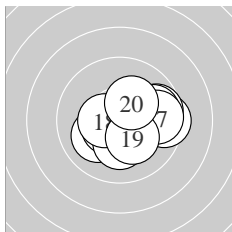

Serie 2:					
	9.5 →	9.7 →	10.1 ↖	10.5 *	9.8 →
	10.2 *	9.7 →	10.5 *	10.2 *	10.3 *
beste Teiler	112.8 (14.) 125.0 (18.) 174.7 (20.)				
Trefferlage	1.07 mm rechts, 0.21 mm tief				
Streuwert	1.62, horizontal: 2.02, vertikal: 1.07				

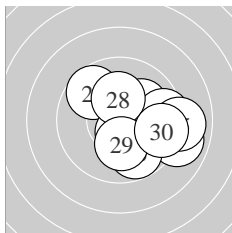

Serie 3:					
	10.1 ↗	9.5 →	9.7 ↘	8.9 →	9.0 →
	9.8 ↘	10.5 *	10.2 *	10.2 *	9.5 →
beste Teiler	101.0 (27.) 180.3 (28.) 197.6 (29.)				
Trefferlage	1.80 mm rechts, 0.27 mm tief				
Streuwert	2.04, horizontal: 2.36, vertikal: 1.66				

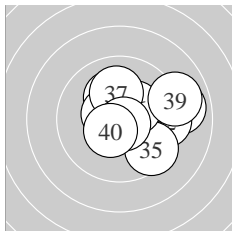

Serie 4:					
	8.9 →	9.4 →	10.2 *	10.5 *	9.5 ↘
	10.3 *	10.1 ↑	10.7 *	9.0 →	10.5 *
beste Teiler	53.2 (38.) 106.1 (34.) 121.6 (40.)				
Trefferlage	1.48 mm rechts, 0.40 mm hoch				
Streuwert	1.93, horizontal: 2.33, vertikal: 1.43				

Unterschrift des Schützen

Ergebnis: **382** (398.6)  
 Serien: 97 95 98 92  
 Zähler: 25 12 3 0 0 0 0 0 0  
 Innenzehner: 20  
 weiteste: 750 (32), 637 (36), 535 (14)  
 beste Teiler 45.6 (35.) 57.3 (10.) 68.1 (25.)  
 Trefferlage 0.47 mm rechts, 0.01 mm tief  
 Streuwert 2.11, horizontal: 2.60, vertikal: 1.45

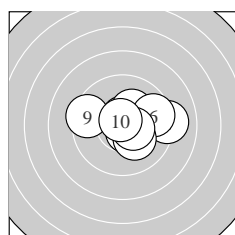
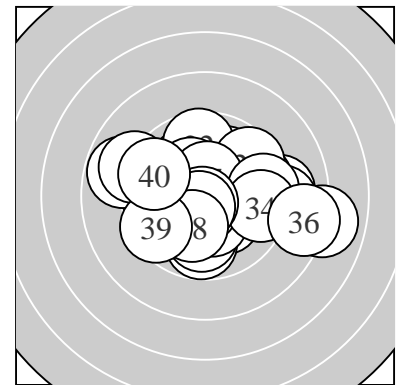

Serie 1:  
 10.6 \*                      9.1 →                      10.5 \*                      10.6 \*                      10.2 \*  
 9.6 ↗                      10.2 \*                      10.5 \*                      9.4 ←                      10.7 \*  
 beste Teiler 57.3 (10.) 81.0 (4.) 84.3 (1.)  
 Trefferlage 0.87 mm rechts, 0.31 mm hoch  
 Streuwert 1.66, horizontal: 2.17, vertikal: 0.89

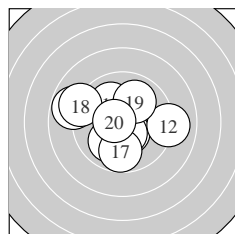

Serie 2:  
 10.4 \*                      9.0 →                      10.0 ↘                      8.8 ←                      10.5 \*  
 10.0 ↙                      9.8 ↓                      9.0 ←                      10.0 ↗                      10.6 \*  
 beste Teiler 87.8 (20.) 121.2 (15.) 127.5 (11.)  
 Trefferlage 0.62 mm links, 0.00 mm  
 Streuwert 2.36, horizontal: 2.81, vertikal: 1.80

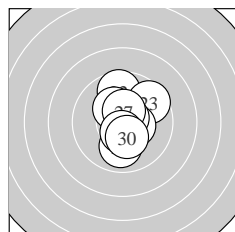

Serie 3:  
 10.4 \*                      9.7 ↑                      9.6 ↗                      10.4 \*                      10.7 \*  
 10.3 \*                      10.5 \*                      10.0 ↓                      10.5 \*                      10.3 \*  
 beste Teiler 68.1 (25.) 104.5 (29.) 117.7 (27.)  
 Trefferlage 0.37 mm rechts, 0.41 mm hoch  
 Streuwert 1.43, horizontal: 1.01, vertikal: 1.76

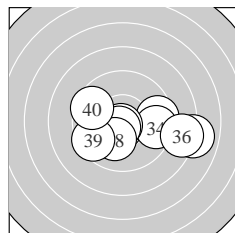

Serie 4:  
 10.7 \*                      8.0 →                      9.5 →                      9.5 →                      10.8 \*  
 8.4 →                      10.6 \*                      10.1 ↓                      9.5 ←                      9.6 ←  
 beste Teiler 45.6 (35.) 74.9 (31.) 78.2 (37.)  
 Trefferlage 1.28 mm rechts, 0.76 mm tief  
 Streuwert 2.70, horizontal: 3.67, vertikal: 1.05

Unterschrift des Schützen

Meyton Elektronik

Ergebnis: **391.4** (373)  
 Serien: 99.4 97.1 94.2 100.7  
 Zähler: 17 19 4 0 0 0 0 0 0 0  
 Innenzehner: 13  
 weiteste: 563 (12), 544 (25), 535 (27)  
 beste Teiler 50.0 (39.) 56.2 (6.) 76.2 (17.)  
 Trefferlage 1.30 mm rechts, 0.25 mm hoch  
 Streuwert 2.15, horizontal: 2.66, vertikal: 1.48

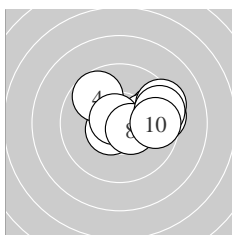
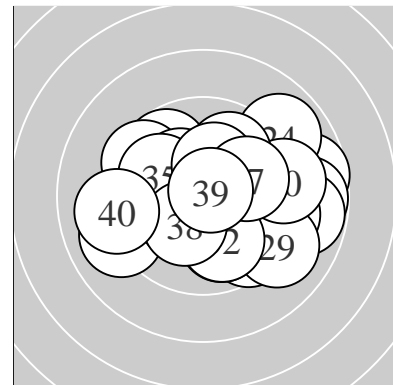

Serie 1:  
 9.5 → 9.7 → 10.6 \* 9.7 ↘ 10.1 →  
 10.7 \* 9.4 → 10.5 \* 9.5 → 9.7 →  
 beste Teiler 56.2 (6.) 96.0 (3.) 111.3 (8.)  
 Trefferlage 1.71 mm rechts, 0.64 mm hoch  
 Streuwert 1.62, horizontal: 2.10, vertikal: 0.92

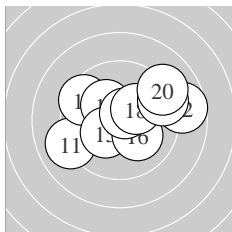

Serie 2:  
 9.0 ← 8.7 → 9.5 ↘ 10.2 \* 10.3 \*  
 10.1 ↘ 10.6 \* 10.3 \* 9.3 → 9.1 →  
 beste Teiler 76.2 (17.) 165.0 (15.) 175.5 (18.)  
 Trefferlage 0.67 mm rechts, 0.57 mm hoch  
 Streuwert 2.51, horizontal: 3.19, vertikal: 1.55

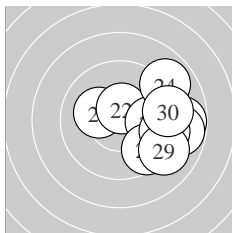

Serie 3:  
 10.2 \* 10.5 \* 9.9 → 8.9 ↗ 8.8 →  
 9.5 ↘ 8.8 → 9.3 → 9.1 ↘ 9.2 →  
 beste Teiler 104.5 (22.) 194.5 (21.) 274.4 (23.)  
 Trefferlage 3.03 mm rechts, 0.17 mm tief  
 Streuwert 2.03, horizontal: 2.29, vertikal: 1.74

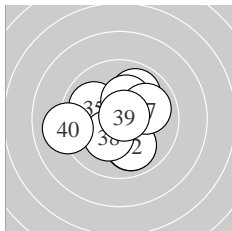

Serie 4:  
 9.9 ↘ 9.9 ↘ 10.5 \* 9.9 ↗ 10.0 ↘  
 10.3 \* 10.0 → 10.3 \* 10.8 \* 9.1 ←  
 beste Teiler 50.0 (39.) 124.1 (33.) 174.8 (36.)  
 Trefferlage 0.22 mm links, 0.01 mm tief  
 Streuwert 1.84, horizontal: 2.04, vertikal: 1.62

Unterschrift des Schützen

Meyton Elektronik

Ergebnis: **377** (394.5)  
 Serien: 93 94 96 94  
 Zähler: 22 14 3 1 0 0 0 0 0 0  
 Innenzehner: 15  
 weiteste: 762 (8), 712 (14), 609 (36)  
 beste Teiler 32.7 (1.) 80.0 (31.) 84.8 (15.)  
 Trefferlage 1.30 mm links, 0.51 mm hoch  
 Streuwert 2.06, horizontal: 2.54, vertikal: 1.44

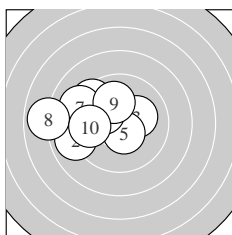
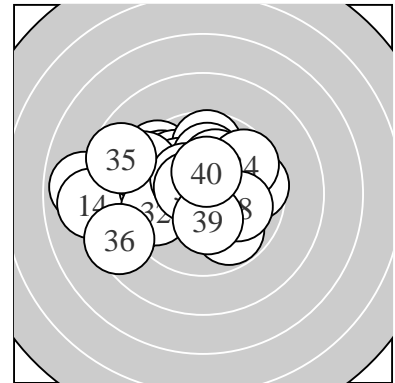

Serie 1:  
 10.8 \*                      9.0 ←                      10.2 \*                      9.4 ↘                      10.5 \*  
 10.2 \*                      9.1 ↘                      7.9 ←                      10.0 ↑                      9.7 ←  
 beste Teiler 32.7 (1.) 114.1 (5.) 194.6 (3.)  
 Trefferlage 2.25 mm links, 0.58 mm hoch  
 Streuwert 2.22, horizontal: 2.83, vertikal: 1.36

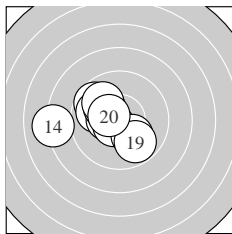

Serie 2:  
 9.7 ↘                      9.9 ↘                      10.4 \*                      8.1 ←                      10.6 \*  
 10.1 ↘                      9.9 ↘                      10.1 ↘                      9.8 ↘                      10.5 \*  
 beste Teiler 84.8 (15.) 124.0 (20.) 133.0 (13.)  
 Trefferlage 1.56 mm links, 0.13 mm hoch  
 Streuwert 1.98, horizontal: 2.42, vertikal: 1.42

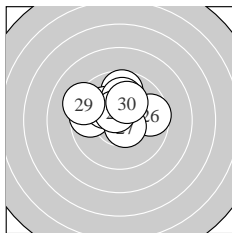

Serie 3:  
 10.3 \*                      9.7 ↑                      9.7 ←                      10.1 ↘                      10.0 ↑  
 9.6 →                      10.6 \*                      10.5 \*                      9.3 ↘                      10.1 ↑  
 beste Teiler 89.9 (27.) 102.8 (28.) 164.3 (21.)  
 Trefferlage 0.40 mm links, 1.32 mm hoch  
 Streuwert 1.63, horizontal: 2.03, vertikal: 1.07

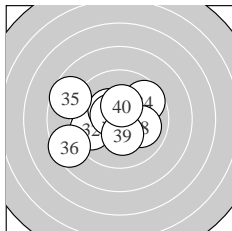

Serie 4:  
 10.6 \*                      9.7 ←                      10.3 \*                      9.7 ↗                      8.7 ↘  
 8.5 ←                      10.5 \*                      10.0 →                      10.3 \*                      10.4 \*  
 beste Teiler 80.0 (31.) 101.0 (37.) 143.6 (40.)  
 Trefferlage 0.99 mm links, 0.00 mm  
 Streuwert 2.30, horizontal: 2.79, vertikal: 1.67

Unterschrift des Schützen

Meyton Elektronik

Ergebnis: **371** (389.4)  
 Serien: 89 95 94 93  
 Zähler: 19 14 6 1 0 0 0 0 0 0  
 Innenzehner: 13  
 weiteste: 904 (7), 732 (29), 708 (34)  
 beste Teiler 45.3 (17.) 56.2 (24.) 63.2 (26.)  
 Trefferlage 0.46 mm links, 0.02 mm tief  
 Streuwert 2.60, horizontal: 3.08, vertikal: 2.02

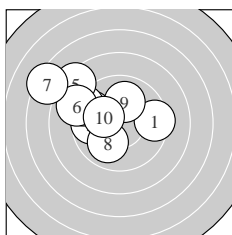
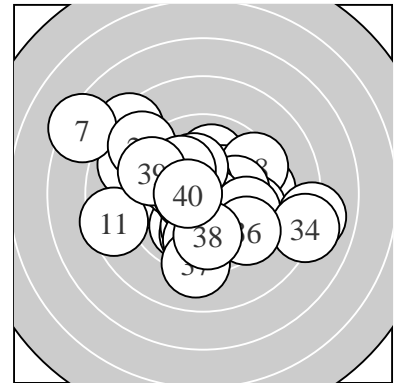

Serie 1:  
 9.4 → 9.6 ↖ 9.7 ← 9.2 ↖ 8.3 ↖  
 8.9 ↖ 7.3 ↖ 10.0 ↙ 10.0 ↑ 10.2 \*  
 beste Teiler 186.2 (10.) 239.4 (9.) 245.6 (8.)  
 Trefferlage 2.62 mm links, 1.50 mm hoch  
 Streuwert 2.68, horizontal: 3.24, vertikal: 1.97

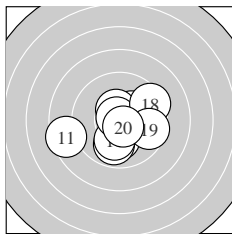

Serie 2:  
 8.5 ← 10.1 ↓ 10.3 \* 9.9 ↓ 10.5 \*  
 10.1 ↓ 10.8 \* 9.4 ↗ 9.6 → 10.6 \*  
 beste Teiler 45.3 (17.) 80.1 (20.) 120.4 (15.)  
 Trefferlage 0.04 mm rechts, 0.62 mm tief  
 Streuwert 2.13, horizontal: 2.56, vertikal: 1.58

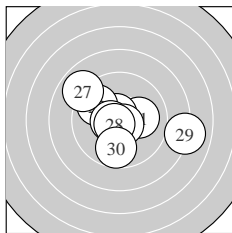

Serie 3:  
 10.1 → 10.7 \* 9.8 ↖ 10.7 \* 10.6 \*  
 10.7 \* 8.9 ↖ 10.7 \* 8.0 → 9.7 ↓  
 beste Teiler 56.2 (24.) 63.2 (26.) 71.4 (28.)  
 Trefferlage 0.08 mm rechts, 0.03 mm tief  
 Streuwert 2.42, horizontal: 2.98, vertikal: 1.68

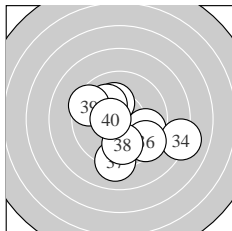

Serie 4:  
 10.4 \* 10.2 \* 9.7 → 8.1 → 10.1 ↖  
 9.5 ↖ 9.1 ↓ 9.9 ↓ 9.5 ↖ 10.6 \*  
 beste Teiler 100.0 (40.) 132.5 (31.) 185.0 (32.)  
 Trefferlage 0.62 mm rechts, 0.94 mm tief  
 Streuwert 2.51, horizontal: 2.84, vertikal: 2.13

Unterschrift des Schützen

Meyton Elektronik

Ergebnis: **385** (400.5)  
 Serien: 95 97 98 95  
 Zähler: 26 13 1 0 0 0 0 0 0  
 Innenzehner: 19  
 weiteste: 640 (3), 469 (23), 467 (26)  
 beste Teiler 19.1 (25.) 23.7 (8.) 69.9 (28.)  
 Trefferlage 0.86 mm rechts, 0.06 mm hoch  
 Streuwert 1.84, horizontal: 2.06, vertikal: 1.58

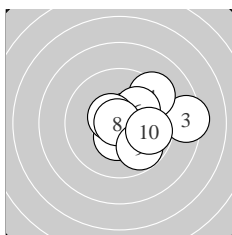
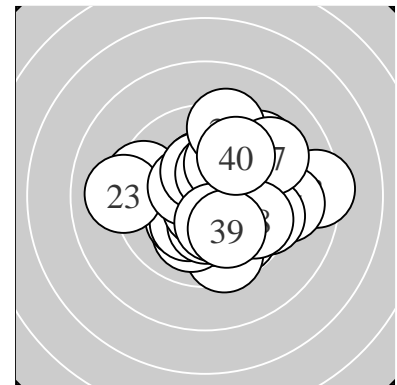

Serie 1:  
 10.3 \*                      10.6 \*                      8.4 →                      9.3 ↗                      10.4 \*  
 10.1 ↗                      10.5 \*                      10.9 \*                      9.8 ↘                      9.8 →  
 beste Teiler 23.7 (8.) 92.6 (2.) 101.8 (7.)  
 Trefferlage 1.59 mm rechts, 0.00 mm  
 Streuwert 1.83, horizontal: 2.14, vertikal: 1.45

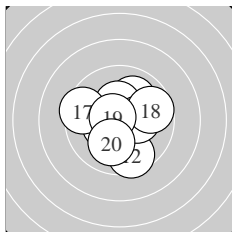

Serie 2:  
 10.0 ↗                      9.6 ↓                      10.2 \*                      10.3 \*                      10.3 \*  
 10.4 \*                      9.5 ←                      9.7 →                      10.7 \*                      10.0 ↓  
 beste Teiler 73.9 (19.) 144.6 (16.) 152.1 (14.)  
 Trefferlage 0.22 mm rechts, 0.02 mm hoch  
 Streuwert 1.78, horizontal: 1.91, vertikal: 1.64

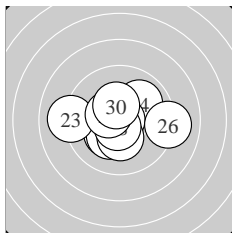

Serie 3:  
 10.2 \*                      10.2 \*                      9.1 ←                      10.0 ↗                      10.9 \*  
 9.1 →                      10.3 \*                      10.7 \*                      10.5 \*                      10.4 \*  
 beste Teiler 19.1 (25.) 69.9 (28.) 118.9 (29.)  
 Trefferlage 0.16 mm links, 0.18 mm tief  
 Streuwert 1.86, horizontal: 2.37, vertikal: 1.15

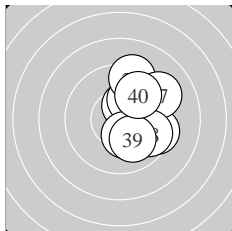

Serie 4:  
 10.0 ↘                      10.4 \*                      10.1 ↗                      9.5 →                      9.3 ↑  
 10.3 \*                      9.2 ↗                      9.7 ↘                      10.0 ↘                      9.8 ↗  
 beste Teiler 140.3 (32.) 160.3 (36.) 213.4 (33.)  
 Trefferlage 1.82 mm rechts, 0.42 mm hoch  
 Streuwert 1.72, horizontal: 1.17, vertikal: 2.13

Unterschrift des Schützen

Meyton Elektronik

Ergebnis: **377** (394.0)  
 Serien: 96 94 94 93  
 Zähler: 21 15 4 0 0 0 0 0 0 0  
 Innenzehner: 14  
 weiteste: 636 (37), 630 (35), 583 (32)  
 beste Teiler 48.0 (28.) 87.0 (27.) 92.7 (22.)  
 Trefferlage 0.86 mm rechts, 0.16 mm hoch  
 Streuwert 2.14, horizontal: 2.55, vertikal: 1.63

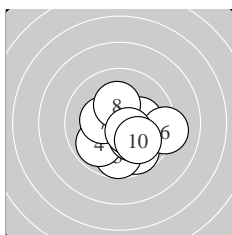
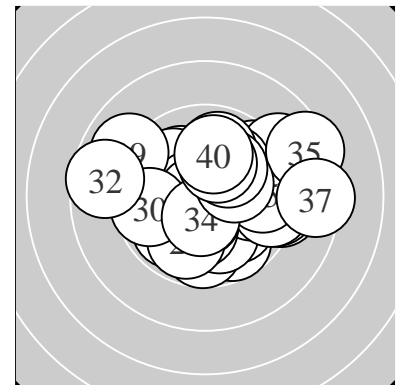

Serie 1:  
 10.2 \* 9.7 ↘ 9.7 ↓ 9.9 ↗ 10.2 \*  
 9.2 → 10.3 \* 10.2 \* 10.5 \* 10.0 ↘  
 beste Teiler 114.0 (9.) 160.6 (7.) 176.7 (8.)  
 Trefferlage 0.76 mm rechts, 0.97 mm tief  
 Streuwert 1.66, horizontal: 1.84, vertikal: 1.46

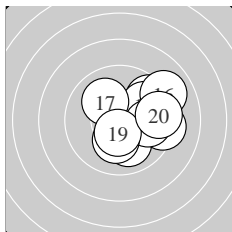

Serie 2:  
 10.0 ↓ 9.3 → 9.6 ↗ 9.8 ↗ 9.9 →  
 9.0 ↗ 10.1 ↘ 10.2 \* 10.5 \* 9.4 →  
 beste Teiler 122.3 (19.) 192.3 (18.) 224.4 (17.)  
 Trefferlage 1.88 mm rechts, 0.20 mm hoch  
 Streuwert 1.87, horizontal: 2.02, vertikal: 1.70

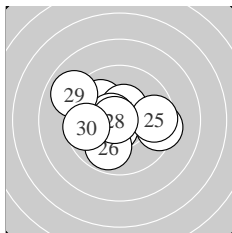

Serie 3:  
 9.4 → 10.6 \* 10.0 ↘ 10.5 \* 9.6 →  
 9.9 ↓ 10.6 \* 10.8 \* 8.9 ↘ 9.7 ←  
 beste Teiler 48.0 (28.) 87.0 (27.) 92.7 (22.)  
 Trefferlage 0.46 mm links, 0.11 mm hoch  
 Streuwert 2.06, horizontal: 2.54, vertikal: 1.42

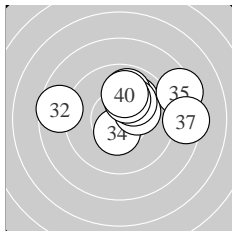

Serie 4:  
 10.0 ↗ 8.6 ← 9.9 ↑ 10.5 \* 8.4 ↗  
 10.2 \* 8.4 → 10.1 ↗ 10.2 \* 10.0 ↑  
 beste Teiler 123.3 (34.) 183.6 (36.) 199.8 (39.)  
 Trefferlage 1.25 mm rechts, 1.32 mm hoch  
 Streuwert 2.50, horizontal: 3.32, vertikal: 1.24

Unterschrift des Schützen

Meyton Elektronik