

Ergebnis:	<b>392</b>	(410.2)
Serien:	96 99 98 99	
Zähler:	33 6 1 0 0 0 0 0 0	
Innenzehner:	30	
weiteste:	593 (2), 472 (4), 423 (38)	
beste Teiler	30.2 (31.) 32.3 (28.) 39.6 (25.)	
Trefferlage	0.59 mm rechts, 0.19 mm hoch	
Streuwert	1.43, horizontal: 1.61, vertikal: 1.23	

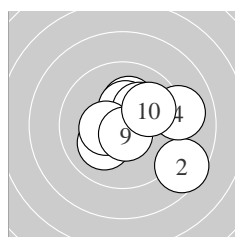

Serie 1:

10.2 *	8.6 ↘	10.4 *	9.1 →	10.5 *
10.1 ↙	10.2 *	10.4 *	10.6 *	9.9 ↗
beste Teiler	77.1 (9.)	106.2 (5.)	140.2 (8.)	
Trefferlage	1.05 mm rechts, 0.02 mm hoch			
Streuwert	1.97, horizontal: 2.25, vertikal: 1.65			

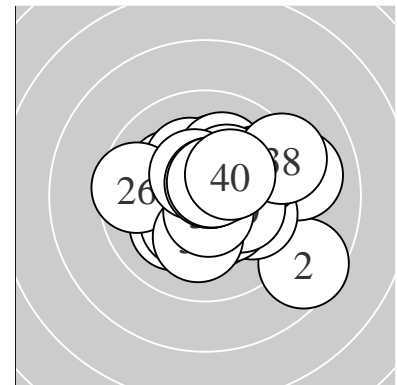
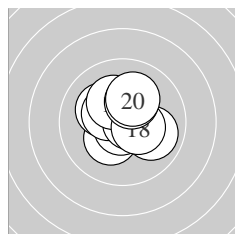

Serie 2:

9.9 ↘	10.3 *	10.2 *	10.8 *	10.4 *
10.7 *	10.2 *	10.4 *	10.2 *	10.1 ↗
beste Teiler	50.9 (14.)	58.1 (16.)	136.9 (18.)	
Trefferlage	0.10 mm rechts, 0.38 mm hoch			
Streuwert	1.22, horizontal: 1.26, vertikal: 1.17			

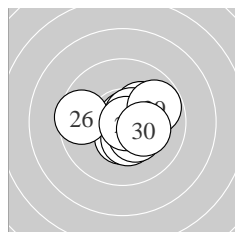

Serie 3:

10.5 *	10.4 *	10.4 *	10.2 *	10.8 *
9.6 ←	10.6 *	10.8 *	9.8 →	10.2 *
beste Teiler	32.3 (28.)	39.6 (25.)	95.2 (27.)	
Trefferlage	0.51 mm rechts, 0.07 mm tief			
Streuwert	1.32, horizontal: 1.60, vertikal: 0.96			

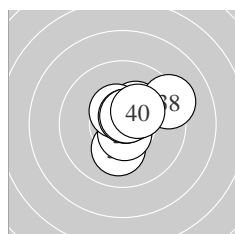

Serie 4:

10.8 *	10.1 ↓	10.6 *	10.5 *	10.3 *
10.5 *	10.7 *	9.3 ↗	10.6 *	10.3 *
beste Teiler	30.2 (31.)	68.9 (37.)	76.4 (39.)	
Trefferlage	0.70 mm rechts, 0.45 mm hoch			
Streuwert	1.19, horizontal: 1.23, vertikal: 1.15			

Unterschrift des Schützen

Meyton Elektronik

Ergebnis:	<b>392</b>	(411.8)
Serien:	97 98 98 99	
Zähler:	32 8 0 0 0 0 0 0 0 0	
Innenzehner:	28	
weiteste:	490 (26), 401 (5), 296 (38)	
beste Teiler	20.0 (20.) 38.4 (37.) 43.0 (2.)	
Trefferlage	0.41 mm rechts, 0.10 mm hoch	
Streuwert	1.35, horizontal: 1.41, vertikal: 1.28	

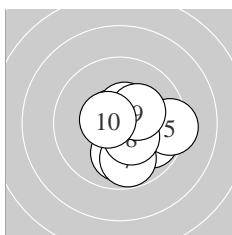
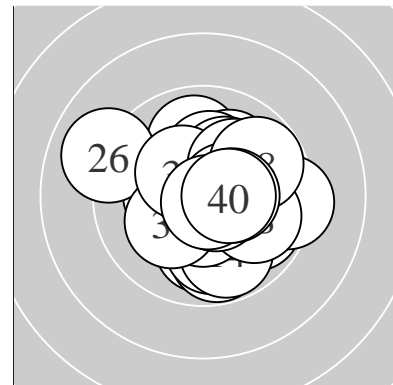

Serie 1:					
	10.7 *	10.8 *	9.8 ↘	10.5 *	9.3 →
	10.0 ↓	9.8 ↓	10.4 *	10.3 *	10.6 *
beste Teiler	43.0 (2.)	73.4 (1.)	97.8 (10.)		
Trefferlage	0.78 mm rechts, 0.50 mm tief				
Streuwert	1.43, horizontal: 1.51, vertikal: 1.34				

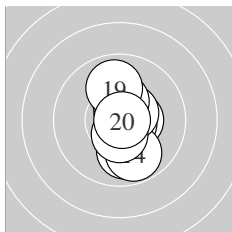

Serie 2:					
	10.5 *	10.0 ↓	10.7 *	9.8 ↓	10.7 *
	10.5 *	10.5 *	10.4 *	9.9 ↑	10.9 *
beste Teiler	20.0 (20.)	70.8 (15.)	75.8 (13.)		
Trefferlage	0.44 mm rechts, 0.11 mm tief				
Streuwert	1.20, horizontal: 0.53, vertikal: 1.61				

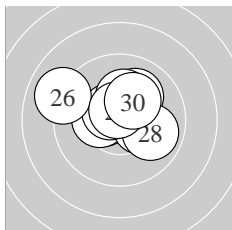

Serie 3:					
	10.4 *	10.3 *	10.3 *	10.1 ↗	10.5 *
	9.0 ↖	10.2 *	9.9 ↘	10.6 *	10.2 *
beste Teiler	81.4 (29.)	101.9 (25.)	126.0 (21.)		
Trefferlage	0.15 mm links, 0.74 mm hoch				
Streuwert	1.59, horizontal: 2.01, vertikal: 1.03				

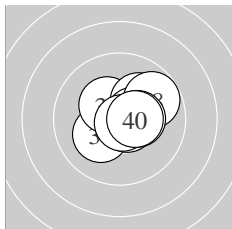

Serie 4:					
	10.2 *	10.8 *	10.4 *	10.7 *	10.1 ↗
	10.5 *	10.8 *	9.8 ↗	10.4 *	10.5 *
beste Teiler	38.4 (37.)	48.1 (32.)	72.4 (34.)		
Trefferlage	0.59 mm rechts, 0.29 mm hoch				
Streuwert	1.06, horizontal: 1.22, vertikal: 0.86				

Unterschrift des Schützen

Ergebnis:	<b>388</b>	(408.0)
Serien:	98	96 97 97
Zähler:	29	10 1 0 0 0 0 0 0 0
Innenzehner:	24	
weiteste:	535	(34), 353 (18), 331 (20)
beste Teiler	9.2	(26.) 25.0 (4.) 42.3 (39.)
Trefferlage	0.15 mm	links, 0.24 mm tief
Streuwert	1.54,	horizontal: 1.60, vertikal: 1.47

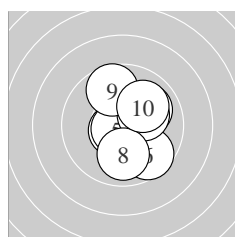
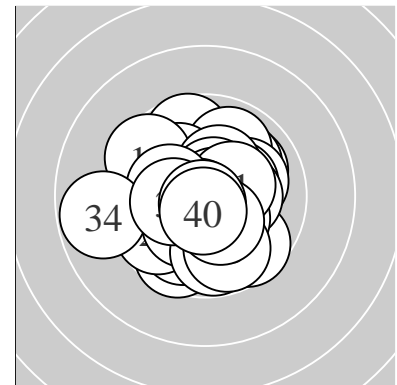

Serie 1:	10.0 ↗	10.6 *	10.4 *	10.9 *	10.7 *
	9.6 ↘	10.2 *	10.0 ↓	9.7 ↑	10.0 ↗
beste Teiler	25.0	(4.) 56.3 (5.)	83.2 (2.)		
Trefferlage	0.69 mm	rechts, 0.03 mm hoch			
Streuwert	1.50,	horizontal: 1.21, vertikal: 1.74			

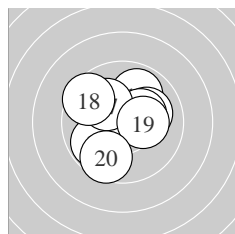

Serie 2:	9.9 ↗	10.1 ↗	10.2 *	10.4 *	9.8 ↗
	10.3 *	10.1 ↘	9.5 ↘	10.2 *	9.6 ↘
beste Teiler	149.0	(14.) 167.3 (16.)	176.0 (19.)		
Trefferlage	0.45 mm	links, 0.32 mm hoch			
Streuwert	1.76,	horizontal: 1.87, vertikal: 1.63			

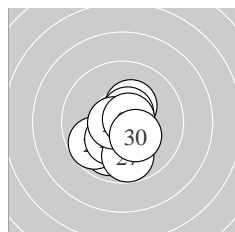

Serie 3:	9.9 ↘	9.7 ↘	10.3 *	10.6 *	10.2 *
	10.9 *	9.8 ↓	10.6 *	10.7 *	10.3 *
beste Teiler	9.2	(26.) 56.7 (29.)	77.3 (28.)		
Trefferlage	0.22 mm	links, 0.72 mm tief			
Streuwert	1.26,	horizontal: 1.09, vertikal: 1.41			

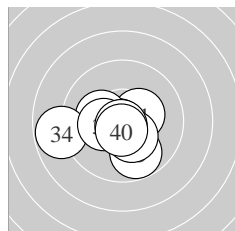

Serie 4:	10.4 *	10.8 *	10.2 *	8.8 ←	9.8 ↘
	10.3 *	10.8 *	10.3 *	10.8 *	10.6 *
beste Teiler	42.3	(39.) 47.0 (37.)	47.4 (32.)		
Trefferlage	0.61 mm	links, 0.62 mm tief			
Streuwert	1.52,	horizontal: 1.94, vertikal: 0.92			

Unterschrift des Schützen

Meyton Elektronik

Ergebnis: **409.2** (392)  
 Serien: 100.9 105.0 101.4 101.9  
 Zähler: 33 6 1 0 0 0 0 0 0  
 Innenzehner: 25  
 weiteste: 522 (40), 455 (6), 452 (2)  
 beste Teiler 23.3 (9.) 25.8 (16.) 41.5 (32.)  
 Trefferlage 0.03 mm rechts, 0.26 mm hoch  
 Streuwert 1.53, horizontal: 1.85, vertikal: 1.12

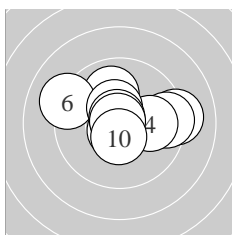
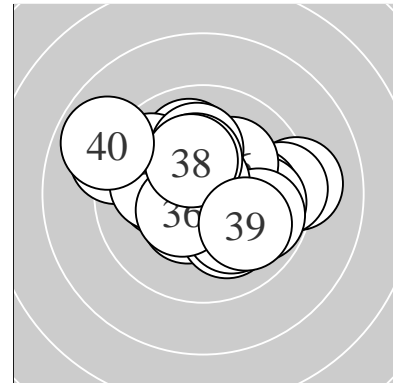

Serie 1:  
 10.7 \*                      9.1 →                      9.4 →                      10.0 →                      10.0 ↑  
 9.1 ↖                      10.4 \*                      10.8 \*                      10.9 \*                      10.5 \*  
 beste Teiler 23.3 (9.) 50.9 (8.) 69.6 (1.)  
 Trefferlage 0.45 mm rechts, 0.50 mm hoch  
 Streuwert 1.92, horizontal: 2.51, vertikal: 1.04

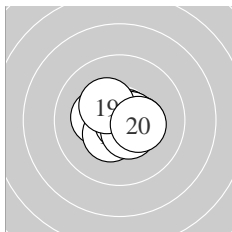

Serie 2:  
 10.7 \*                      10.6 \*                      10.3 \*                      10.4 \*                      10.4 \*  
 10.9 \*                      10.6 \*                      10.5 \*                      10.3 \*                      10.3 \*  
 beste Teiler 25.8 (16.) 51.8 (11.) 78.7 (12.)  
 Trefferlage 0.20 mm rechts, 0.18 mm tief  
 Streuwert 0.88, horizontal: 1.05, vertikal: 0.66

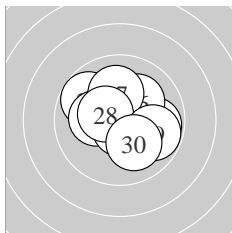

Serie 3:  
 10.3 \*                      9.8 ↖                      10.2 \*                      10.7 \*                      9.8 →  
 10.1 ↗                      10.1 ↑                      10.5 \*                      9.8 →                      10.1 ↘  
 beste Teiler 67.1 (24.) 124.0 (28.) 167.8 (21.)  
 Trefferlage 0.11 mm rechts, 0.33 mm hoch  
 Streuwert 1.58, horizontal: 1.82, vertikal: 1.30

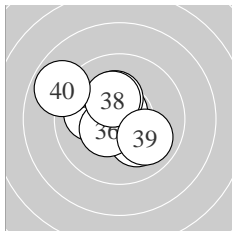

Serie 4:  
 10.4 \*                      10.8 \*                      10.0 ←                      10.1 ↘                      10.7 \*  
 10.4 \*                      10.3 \*                      10.3 \*                      10.0 ↘                      8.9 ↖  
 beste Teiler 41.5 (32.) 54.0 (35.) 126.8 (36.)  
 Trefferlage 0.64 mm links, 0.40 mm hoch  
 Streuwert 1.62, horizontal: 1.84, vertikal: 1.37

Unterschrift des Schützen

Meyton Elektronik

Ergebnis: **389** (407.1)  
 Serien: 97 98 97 97  
 Zähler: 30 9 1 0 0 0 0 0 0 0  
 Innenzehner: 21  
 weiteste: 518 (30), 411 (12), 377 (36)  
 beste Teiler 7.2 (28.) 32.9 (13.) 46.6 (29.)  
 Trefferlage 0.08 mm rechts, 0.36 mm hoch  
 Streuwert 1.59, horizontal: 1.81, vertikal: 1.34

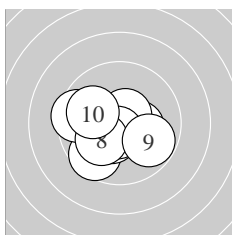
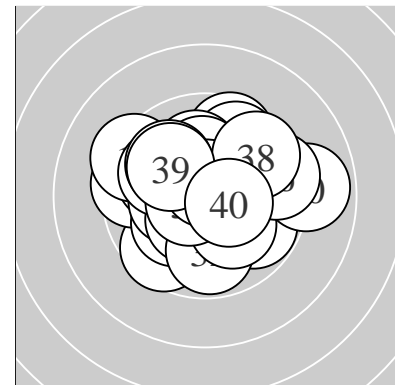

Serie 1:  
 9.6 ↘ 10.4 \* 10.6 \* 10.3 \* 10.6 \*  
 10.6 \* 9.5 ← 10.1 ↗ 9.8 ↘ 10.0 ↖  
 beste Teiler 80.0 (3.) 82.4 (6.) 85.4 (5.)  
 Trefferlage 0.50 mm links, 0.55 mm tief  
 Streuwert 1.57, horizontal: 1.90, vertikal: 1.15

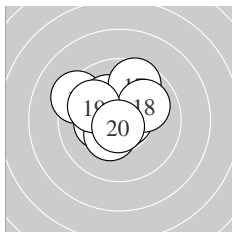

Serie 2:  
 10.3 \* 9.3 ↖ 10.8 \* 10.7 \* 10.4 \*  
 10.2 \* 9.6 ↑ 10.0 ↗ 10.0 ↖ 10.7 \*  
 beste Teiler 32.9 (13.) 54.5 (20.) 56.0 (14.)  
 Trefferlage 0.54 mm links, 0.73 mm hoch  
 Streuwert 1.50, horizontal: 1.69, vertikal: 1.29

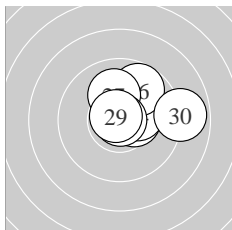

Serie 3:  
 10.8 \* 10.7 \* 10.5 \* 10.3 \* 10.1 ↑  
 9.7 ↗ 10.1 ↑ 10.9 \* 10.8 \* 8.9 →  
 beste Teiler 7.2 (28.) 46.6 (29.) 50.9 (21.)  
 Trefferlage 0.94 mm rechts, 0.89 mm hoch  
 Streuwert 1.36, horizontal: 1.66, vertikal: 0.96

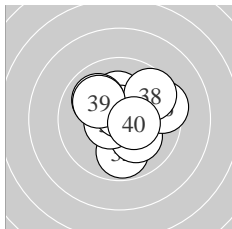

Serie 4:  
 10.2 \* 9.8 ↓ 10.1 ↘ 10.6 \* 10.7 \*  
 9.4 → 10.0 ↖ 9.6 ↗ 10.0 ↖ 10.4 \*  
 beste Teiler 64.2 (35.) 85.4 (34.) 126.9 (40.)  
 Trefferlage 0.46 mm rechts, 0.37 mm hoch  
 Streuwert 1.69, horizontal: 1.78, vertikal: 1.59

Unterschrift des Schützen

Meyton Elektronik

Ergebnis: **390** (406.9)  
 Serien: 98 98 98 96  
 Zähler: 30 10 0 0 0 0 0 0 0 0  
 Innenzehner: 23  
 weiteste: 434 (38), 419 (21), 394 (30)  
 beste Teiler 18.0 (19.) 31.0 (39.) 57.8 (33.)  
 Trefferlage 0.44 mm rechts, 0.20 mm hoch  
 Streuwert 1.52, horizontal: 1.68, vertikal: 1.34

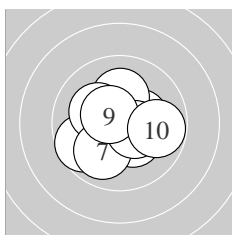
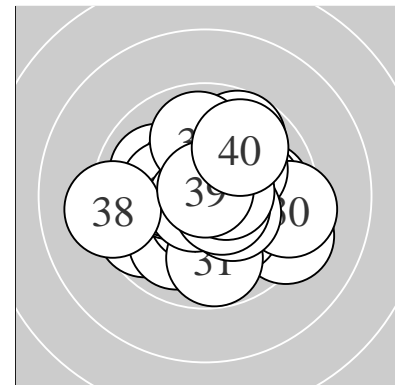

Serie 1:  
 10.5 \* 10.3 \* 10.3 \* 10.1 ↑ 9.7 ↙  
 10.2 \* 10.0 ↙ 10.4 \* 10.5 \* 9.8 →  
 beste Teiler 103.5 (9.) 125.8 (1.) 126.8 (8.)  
 Trefferlage 0.02 mm rechts, 0.05 mm tief  
 Streuwert 1.52, horizontal: 1.70, vertikal: 1.32

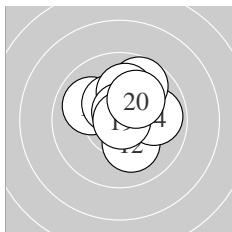

Serie 2:  
 10.0 ↖ 10.2 \* 10.4 \* 9.9 → 9.7 ↗  
 10.2 \* 10.1 ↑ 10.7 \* 10.9 \* 10.1 ↗  
 beste Teiler 18.0 (19.) 65.4 (18.) 145.4 (13.)  
 Trefferlage 0.47 mm rechts, 0.96 mm hoch  
 Streuwert 1.29, horizontal: 1.31, vertikal: 1.27

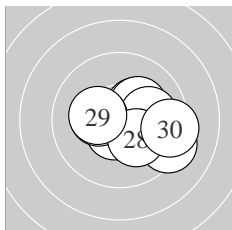

Serie 3:  
 9.3 ↘ 10.3 \* 10.6 \* 10.4 \* 10.2 \*  
 10.0 → 10.3 \* 10.2 \* 10.3 \* 9.4 →  
 beste Teiler 93.0 (23.) 139.9 (24.) 157.2 (22.)  
 Trefferlage 1.12 mm rechts, 0.22 mm tief  
 Streuwert 1.54, horizontal: 1.94, vertikal: 1.00

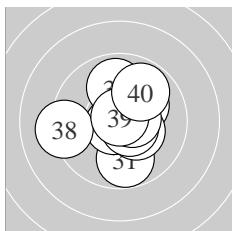

Serie 4:  
 9.8 ↓ 10.1 ↗ 10.7 \* 10.4 \* 9.9 ↑  
 10.6 \* 10.6 \* 9.2 ← 10.8 \* 9.8 ↗  
 beste Teiler 31.0 (39.) 57.8 (33.) 92.9 (36.)  
 Trefferlage 0.16 mm rechts, 0.14 mm hoch  
 Streuwert 1.67, horizontal: 1.74, vertikal: 1.60

Unterschrift des Schützen

Meyton Elektronik

Ergebnis:	<b>392</b>	(407.4)
Serien:	96 98 100 98	
Zähler:	32 8 0 0 0 0 0 0 0 0	
Innenzehner:	22	
weiteste:	470 (6), 418 (2), 367 (18)	
beste Teiler	7.0 (22.) 38.8 (34.) 53.4 (14.)	
Trefferlage	0.30 mm rechts, 0.22 mm tief	
Streuwert	1.53, horizontal: 1.66, vertikal: 1.39	

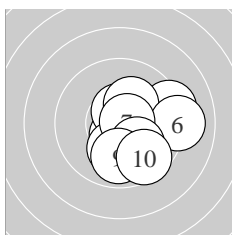
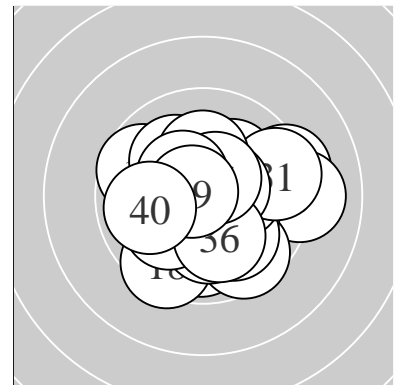

Serie 1:	10.6 *	9.3 →	10.6 *	10.2 *	10.1 ↓
	9.1 →	10.7 *	10.1 ↘	9.9 ↓	9.6 ↘
beste Teiler	62.8 (7.)	98.1 (3.)	99.4 (1.)		
Trefferlage	1.28 mm rechts, 0.62 mm tief				
Streuwert	1.71, horizontal: 1.79, vertikal: 1.62				

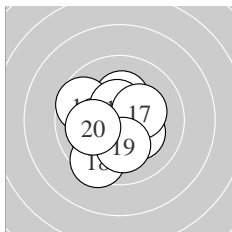

Serie 2:	10.2 *	10.3 *	9.7 ↖	10.7 *	10.1 ↙
	10.5 *	10.3 *	9.5 ↓	10.1 ↓	10.1 ←
beste Teiler	53.4 (14.)	107.0 (16.)	173.3 (17.)		
Trefferlage	0.57 mm links, 0.30 mm tief				
Streuwert	1.56, horizontal: 1.53, vertikal: 1.59				

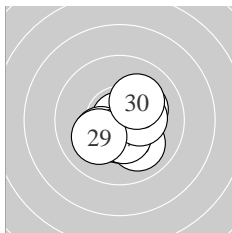

Serie 3:	10.3 *	10.9 *	10.2 *	10.2 *	10.5 *
	10.0 ↘	10.4 *	10.3 *	10.1 ↙	10.1 ↗
beste Teiler	7.0 (22.)	124.0 (25.)	132.6 (27.)		
Trefferlage	0.47 mm rechts, 0.40 mm tief				
Streuwert	1.20, horizontal: 1.28, vertikal: 1.12				

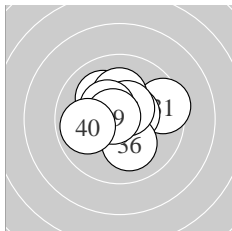

Serie 4:	9.5 →	10.1 ↖	10.2 *	10.8 *	10.5 *
	10.1 ↓	10.5 *	10.4 *	10.7 *	9.9 ←
beste Teiler	38.8 (34.)	57.9 (39.)	105.1 (37.)		
Trefferlage	0.02 mm rechts, 0.41 mm hoch				
Streuwert	1.42, horizontal: 1.64, vertikal: 1.16				

Unterschrift des Schützen

Meyton Elektronik

Ergebnis: **391** (408.3)  
 Serien: 98 98 98 97  
 Zähler: 31 9 0 0 0 0 0 0 0 0  
 Innenzehner: 25  
 weiteste: 394 (17), 372 (33), 361 (1)  
 beste Teiler 27.2 (26.) 60.2 (25.) 64.4 (8.)  
 Trefferlage 0.30 mm links, 0.17 mm hoch  
 Streuwert 1.46, horizontal: 1.53, vertikal: 1.38

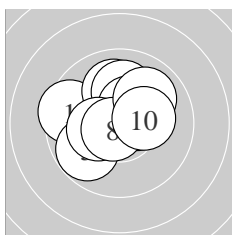
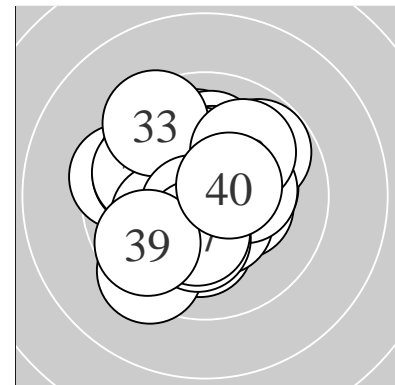

Serie 1:  
 9.5 ↖ 10.0 ↑ 10.1 ↑ 10.4 \* 9.8 ↙  
 10.3 \* 10.5 \* 10.7 \* 10.0 ↗ 10.3 \*  
 beste Teiler 64.4 (8.) 123.9 (7.) 129.8 (4.)  
 Trefferlage 0.25 mm links, 0.60 mm hoch  
 Streuwert 1.54, horizontal: 1.75, vertikal: 1.30

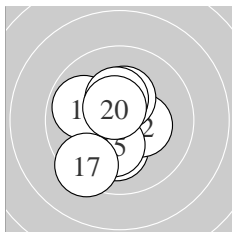

Serie 2:  
 10.1 ↓ 10.3 \* 10.6 \* 10.4 \* 10.2 \*  
 9.9 ↖ 9.4 ↙ 10.3 \* 10.3 \* 10.6 \*  
 beste Teiler 96.0 (20.) 96.3 (13.) 127.0 (14.)  
 Trefferlage 0.65 mm links, 0.24 mm tief  
 Streuwert 1.42, horizontal: 1.20, vertikal: 1.61

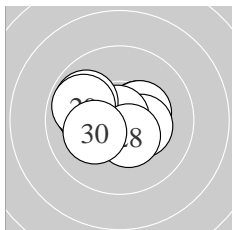

Serie 3:  
 10.4 \* 10.3 \* 10.3 \* 10.0 ↖ 10.7 \*  
 10.8 \* 9.9 ↖ 10.4 \* 9.9 ↖ 10.2 \*  
 beste Teiler 27.2 (26.) 60.2 (25.) 127.2 (28.)  
 Trefferlage 0.45 mm links, 0.12 mm hoch  
 Streuwert 1.30, horizontal: 1.66, vertikal: 0.79

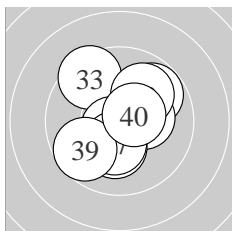

Serie 4:  
 9.8 ↗ 10.7 \* 9.5 ↘ 10.3 \* 10.2 \*  
 10.7 \* 10.3 \* 10.0 ↗ 9.7 ↙ 10.5 \*  
 beste Teiler 71.4 (36.) 75.8 (32.) 111.0 (40.)  
 Trefferlage 0.14 mm rechts, 0.20 mm hoch  
 Streuwert 1.65, horizontal: 1.58, vertikal: 1.71

Unterschrift des Schützen

Meyton Elektronik