

Ergebnis: **396** (411.8)  
 Serien: 98 99 99 100  
 Zähler: 36 4 0 0 0 0 0 0 0 0  
 Innenzehner: 33  
 weiteste: 396 (26), 390 (4), 379 (15)  
 beste Teiler 34.7 (38.) 44.7 (8.) 46.6 (16.)  
 Trefferlage 0.42 mm rechts, 0.46 mm hoch  
 Streuwert 1.24, horizontal: 1.48, vertikal: 0.92

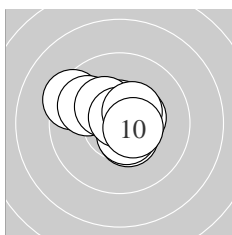

Serie 1:  
 10.4 \* 10.5 \* 10.6 \* 9.4 ↖ 9.9 ↖  
 10.6 \* 10.3 \* 10.8 \* 10.5 \* 10.5 \*  
 beste Teiler 44.7 (8.) 97.1 (3.) 98.7 (6.)  
 Trefferlage 0.28 mm links, 0.47 mm hoch  
 Streuwert 1.30, horizontal: 1.58, vertikal: 0.93

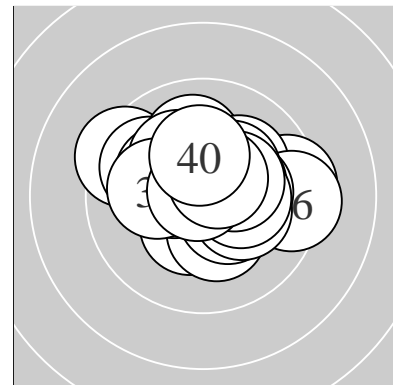
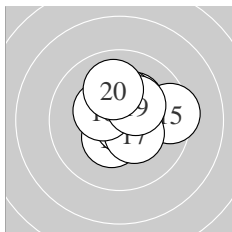

Serie 2:  
 10.4 \* 10.4 \* 10.3 \* 10.3 \* 9.4 →  
 10.8 \* 10.4 \* 10.4 \* 10.3 \* 10.0 ↑  
 beste Teiler 46.6 (16.) 140.2 (12.) 141.5 (18.)  
 Trefferlage 0.69 mm rechts, 0.45 mm hoch  
 Streuwert 1.28, horizontal: 1.39, vertikal: 1.16

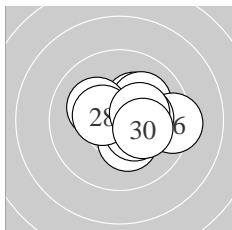

Serie 3:  
 10.3 \* 10.1 ↗ 10.3 \* 10.2 \* 10.4 \*  
 9.4 → 10.2 \* 10.4 \* 10.3 \* 10.2 \*  
 beste Teiler 132.9 (28.) 136.8 (25.) 158.8 (29.)  
 Trefferlage 1.04 mm rechts, 0.15 mm hoch  
 Streuwert 1.32, horizontal: 1.60, vertikal: 0.96

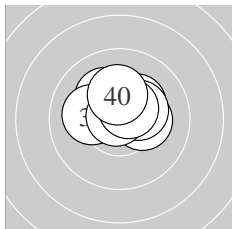

Serie 4:  
 10.2 \* 10.4 \* 10.3 \* 10.7 \* 10.3 \*  
 10.3 \* 10.1 ← 10.8 \* 10.5 \* 10.2 \*  
 beste Teiler 34.7 (38.) 62.0 (34.) 102.9 (39.)  
 Trefferlage 0.26 mm rechts, 0.75 mm hoch  
 Streuwert 0.95, horizontal: 1.20, vertikal: 0.60

Unterschrift des Schützen

Meyton Elektronik

Ergebnis: **396** (414.9)  
 Serien: 99 100 97 100  
 Zähler: 36 4 0 0 0 0 0 0 0 0  
 Innenzehner: 30  
 weiteste: 317 (22), 278 (25), 276 (2)  
 beste Teiler 9.4 (16.) 25.7 (4.) 27.5 (9.)  
 Trefferlage 0.00 mm , 0.53 mm hoch  
 Streuwert 1.09, horizontal: 0.99, vertikal: 1.19

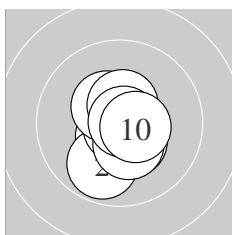
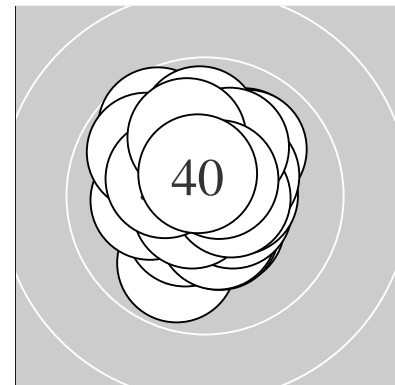

Serie 1:  
 10.6 \* 9.8 ↘ 10.4 \* 10.9 \* 10.4 \*  
 10.4 \* 10.7 \* 10.5 \* 10.8 \* 10.5 \*  
 beste Teiler 25.7 (4.) 27.5 (9.) 59.0 (7.)  
 Trefferlage 0.08 mm rechts, 0.37 mm tief  
 Streuwert 0.93, horizontal: 0.69, vertikal: 1.12

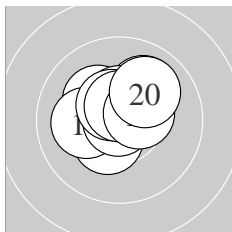

Serie 2:  
 10.2 \* 10.0 ↗ 10.4 \* 10.1 ← 10.5 \*  
 10.9 \* 10.5 \* 10.6 \* 10.4 \* 10.0 ↗  
 beste Teiler 9.4 (16.) 88.0 (18.) 107.8 (17.)  
 Trefferlage 0.05 mm links, 0.68 mm hoch  
 Streuwert 1.09, horizontal: 1.22, vertikal: 0.94

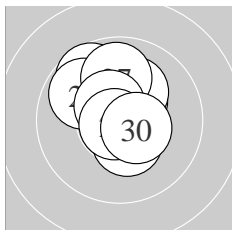

Serie 3:  
 10.4 \* 9.7 ↘ 10.4 \* 10.0 ↑ 9.8 ↘  
 10.2 \* 9.9 ↑ 10.5 \* 10.8 \* 10.5 \*  
 beste Teiler 41.2 (29.) 110.6 (28.) 116.2 (30.)  
 Trefferlage 0.22 mm links, 1.10 mm hoch  
 Streuwert 1.25, horizontal: 1.10, vertikal: 1.38

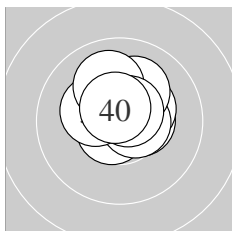

Serie 4:  
 10.5 \* 10.7 \* 10.4 \* 10.3 \* 10.6 \*  
 10.3 \* 10.1 ↗ 10.0 ↘ 10.6 \* 10.6 \*  
 beste Teiler 70.0 (32.) 81.5 (39.) 88.5 (40.)  
 Trefferlage 0.17 mm rechts, 0.74 mm hoch  
 Streuwert 0.90, horizontal: 0.96, vertikal: 0.83

Unterschrift des Schützen

Meyton Elektronik

Ergebnis: **393** (416.1)  
 Serien: 98 98 100 97  
 Zähler: 33 7 0 0 0 0 0 0 0 0  
 Innenzehner: 29  
 weiteste: 368 (18), 337 (10), 293 (19)  
 beste Teiler 16.5 (3.) 22.4 (8.) 24.1 (14.)  
 Trefferlage 0.25 mm rechts, 0.22 mm tief  
 Streuwert 1.17, horizontal: 1.40, vertikal: 0.88

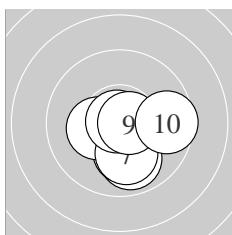
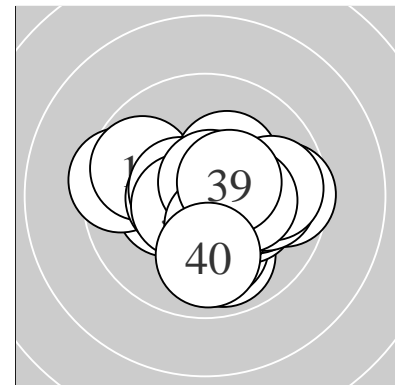

Serie 1:  
 10.6 \* 9.9 ↓ 10.9 \* 10.1 ↓ 10.7 \*  
 10.3 \* 10.1 ↓ 10.9 \* 10.7 \* 9.6 →  
 beste Teiler 16.5 (3.) 22.4 (8.) 65.7 (5.)  
 Trefferlage 0.43 mm rechts, 0.79 mm tief  
 Streuwert 1.14, horizontal: 1.24, vertikal: 1.04

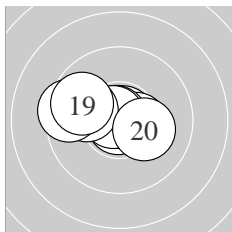

Serie 2:  
 10.8 \* 10.8 \* 10.5 \* 10.9 \* 10.8 \*  
 10.8 \* 10.0 ← 9.5 ← 9.8 ← 10.2 \*  
 beste Teiler 24.1 (14.) 30.0 (11.) 32.6 (12.)  
 Trefferlage 0.64 mm links, 0.23 mm hoch  
 Streuwert 1.27, horizontal: 1.72, vertikal: 0.53

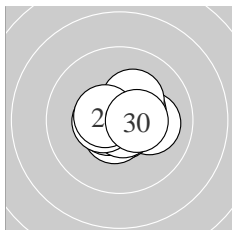

Serie 3:  
 10.1 → 10.7 \* 10.6 \* 10.5 \* 10.6 \*  
 10.7 \* 10.3 \* 10.5 \* 10.5 \* 10.5 \*  
 beste Teiler 51.0 (26.) 59.7 (22.) 83.8 (25.)  
 Trefferlage 0.24 mm rechts, 0.02 mm tief  
 Streuwert 0.90, horizontal: 1.10, vertikal: 0.65

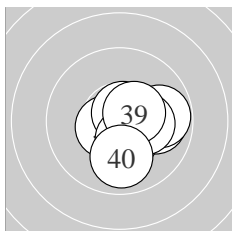

Serie 4:  
 10.5 \* 10.5 \* 9.9 → 10.7 \* 9.8 →  
 10.7 \* 10.4 \* 10.3 \* 10.5 \* 9.9 ↓  
 beste Teiler 63.3 (36.) 73.3 (34.) 102.0 (31.)  
 Trefferlage 0.99 mm rechts, 0.29 mm tief  
 Streuwert 1.06, horizontal: 1.14, vertikal: 0.97

Unterschrift des Schützen

Meyton Elektronik

Ergebnis: **397** (414.2)  
 Serien: 99 100 99 99  
 Zähler: 37 3 0 0 0 0 0 0 0 0  
 Innenzehner: 29  
 weiteste: 305 (6), 274 (26), 257 (34)  
 beste Teiler 26.0 (14.) 39.5 (27.) 51.6 (9.)  
 Trefferlage 0.33 mm rechts, 0.00 mm  
 Streuwert 1.16, horizontal: 1.18, vertikal: 1.15

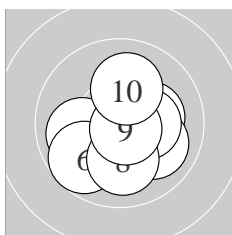
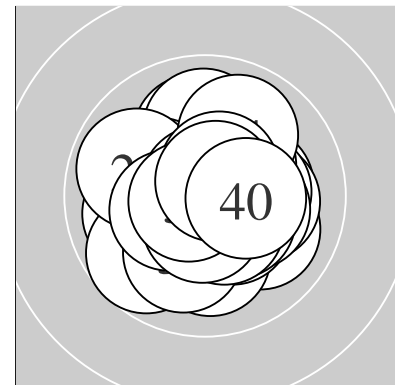

Serie 1:  
 10.6 \*                      10.2 \*                      10.3 \*                      10.0 ↘                      10.0 ←  
 9.7 ↙                      10.3 \*                      10.1 ↓                      10.7 \*                      10.1 ↑  
 beste Teiler 51.6 (9.) 77.8 (1.) 158.0 (7.)  
 Trefferlage 0.28 mm rechts, 0.61 mm tief  
 Streuwert 1.41, horizontal: 1.50, vertikal: 1.30

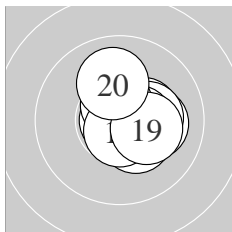

Serie 2:  
 10.1 →                      10.4 \*                      10.3 \*                      10.8 \*                      10.5 \*  
 10.6 \*                      10.4 \*                      10.7 \*                      10.3 \*                      10.0 ↑  
 beste Teiler 26.0 (14.) 66.0 (18.) 97.8 (16.)  
 Trefferlage 0.81 mm rechts, 0.12 mm hoch  
 Streuwert 0.94, horizontal: 0.94, vertikal: 0.94

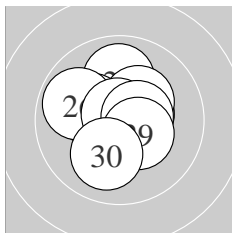

Serie 3:  
 10.0 ↑                      10.5 \*                      10.2 \*                      10.5 \*                      10.3 \*  
 9.9 ↖                      10.8 \*                      10.5 \*                      10.4 \*                      10.1 ↓  
 beste Teiler 39.5 (27.) 111.0 (28.) 111.9 (24.)  
 Trefferlage 0.00 mm , 0.40 mm hoch  
 Streuwert 1.28, horizontal: 1.34, vertikal: 1.22

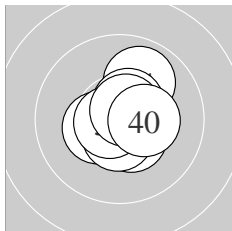

Serie 4:  
 10.4 \*                      10.7 \*                      10.7 \*                      9.9 ↗                      10.4 \*  
 10.6 \*                      10.5 \*                      10.7 \*                      10.7 \*                      10.3 \*  
 beste Teiler 53.4 (32.) 58.0 (33.) 64.1 (38.)  
 Trefferlage 0.24 mm rechts, 0.06 mm hoch  
 Streuwert 0.93, horizontal: 0.86, vertikal: 0.99

Unterschrift des Schützen

Meyton Elektronik

Ergebnis: **395** (416.2)  
 Serien: 98 99 99 99  
 Zähler: 35 5 0 0 0 0 0 0 0 0  
 Innenzehner: 32  
 weiteste: 318 (12), 312 (9), 309 (6)  
 beste Teiler 13.6 (34.) 18.9 (40.) 37.3 (28.)  
 Trefferlage 0.01 mm links, 0.59 mm hoch  
 Streuwert 1.08, horizontal: 1.21, vertikal: 0.93

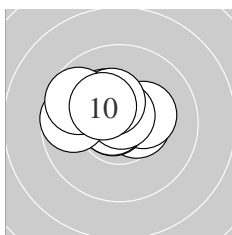
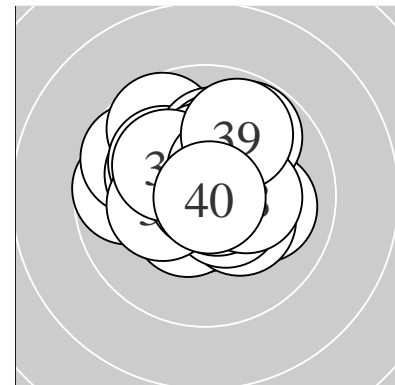

Serie 1:  
 10.5 \* 10.3 \* 10.8 \* 10.8 \* 10.7 \*  
 9.7 ← 10.3 \* 10.3 \* 9.7 ↖ 10.3 \*  
 beste Teiler 43.5 (3.) 49.2 (4.) 52.3 (5.)  
 Trefferlage 0.65 mm links, 0.68 mm hoch  
 Streuwert 1.13, horizontal: 1.47, vertikal: 0.61

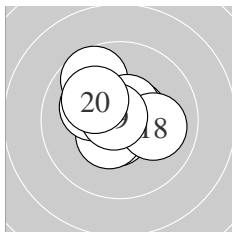

Serie 2:  
 10.6 \* 9.7 ↖ 10.7 \* 10.5 \* 10.5 \*  
 10.2 \* 10.6 \* 10.0 → 10.8 \* 10.1 ↖  
 beste Teiler 45.4 (19.) 58.7 (13.) 87.0 (11.)  
 Trefferlage 0.22 mm links, 0.44 mm hoch  
 Streuwert 1.20, horizontal: 1.30, vertikal: 1.09

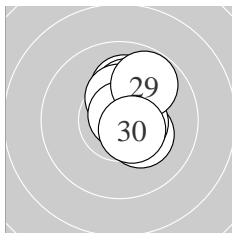

Serie 3:  
 10.3 \* 10.1 ↑ 10.2 \* 10.7 \* 10.5 \*  
 10.4 \* 10.8 \* 10.8 \* 9.8 ↗ 10.5 \*  
 beste Teiler 37.3 (28.) 39.6 (27.) 64.3 (24.)  
 Trefferlage 0.64 mm rechts, 0.71 mm hoch  
 Streuwert 0.92, horizontal: 0.56, vertikal: 1.17

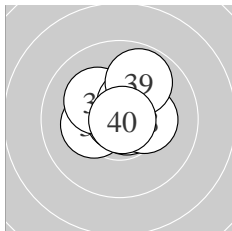

Serie 4:  
 10.3 \* 10.7 \* 10.7 \* 10.9 \* 10.2 \*  
 10.7 \* 10.5 \* 10.3 \* 9.8 ↗ 10.9 \*  
 beste Teiler 13.6 (34.) 18.9 (40.) 51.2 (36.)  
 Trefferlage 0.16 mm rechts, 0.53 mm hoch  
 Streuwert 0.96, horizontal: 1.06, vertikal: 0.85

Unterschrift des Schützen

Meyton Elektronik

Ergebnis:	<b>395</b>	(412.7)
Serien:	98 99 100 98	
Zähler:	35 5 0 0 0 0 0 0 0 0	
Innenzehner:	33	
weiteste:	327 (3), 293 (6), 268 (36)	
beste Teiler	23.7 (13.) 59.0 (9.) 62.0 (21.)	
Trefferlage	0.29 mm rechts, 0.08 mm hoch	
Streuwert	1.21, horizontal: 1.13, vertikal: 1.30	

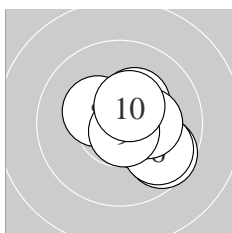
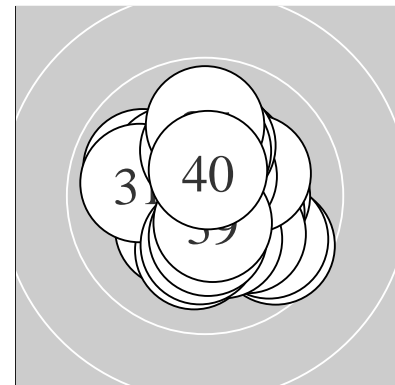

Serie 1:	10.3 *	10.4 *	9.6 ↘	10.3 *	10.6 *
	9.8 ↘	10.3 *	10.3 *	10.7 *	10.5 *
beste Teiler	59.0 (9.)	77.0 (5.)	124.5 (10.)		
Trefferlage	1.09 mm rechts, 0.19 mm tief				
Streuwert	1.11, horizontal: 1.16, vertikal: 1.06				

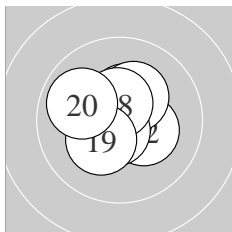

Serie 2:	10.6 *	10.3 *	10.9 *	10.5 *	10.4 *
	10.3 *	10.7 *	10.5 *	10.3 *	9.9 ↖
beste Teiler	23.7 (13.)	73.8 (17.)	96.1 (11.)		
Trefferlage	0.15 mm links, 0.32 mm hoch				
Streuwert	1.05, horizontal: 1.15, vertikal: 0.95				

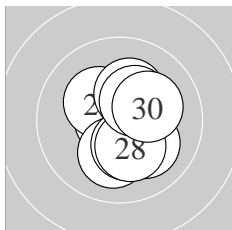

Serie 3:	10.7 *	10.3 *	10.1 ↘	10.3 *	10.2 *
	10.1 ↓	10.3 *	10.2 *	10.3 *	10.2 *
beste Teiler	62.0 (21.)	154.4 (29.)	162.7 (27.)		
Trefferlage	0.34 mm rechts, 0.35 mm tief				
Streuwert	1.25, horizontal: 0.98, vertikal: 1.47				

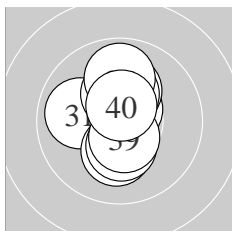

Serie 4:	9.9 ↖	10.6 *	10.2 *	10.3 *	10.3 *
	9.9 ↑	10.2 *	10.3 *	10.5 *	10.6 *
beste Teiler	89.0 (32.)	98.6 (40.)	106.0 (39.)		
Trefferlage	0.12 mm links, 0.58 mm hoch				
Streuwert	1.27, horizontal: 0.86, vertikal: 1.57				

Unterschrift des Schützen

Meyton Elektronik

Ergebnis: **392** (408.7)  
 Serien: 98 98 99 97  
 Zähler: 32 8 0 0 0 0 0 0 0 0  
 Innenzehner: 23  
 weiteste: 418 (5), 350 (30), 341 (9)  
 beste Teiler 26.0 (16.) 31.7 (26.) 34.0 (34.)  
 Trefferlage 0.30 mm links, 0.55 mm hoch  
 Streuwert 1.40, horizontal: 1.31, vertikal: 1.49

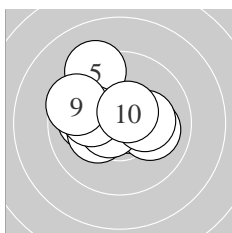
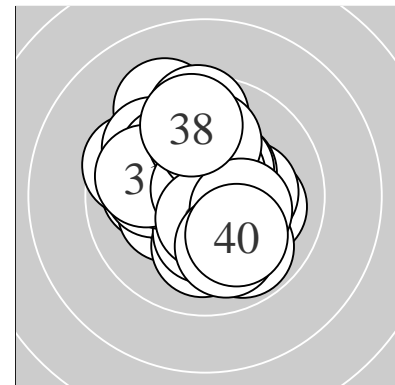

Serie 1:  
 10.7 \*                      10.0 ←                      10.0 →                      10.3 \*                      9.3 ↗  
 10.6 \*                      10.2 \*                      10.1 ←                      9.6 ↖                      10.5 \*  
 beste Teiler 69.1 (1.) 79.1 (6.) 101.0 (10.)  
 Trefferlage 0.62 mm links, 0.55 mm hoch  
 Streuwert 1.59, horizontal: 1.85, vertikal: 1.29

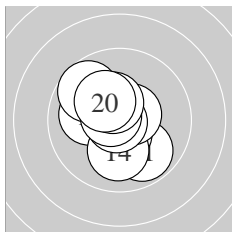

Serie 2:  
 9.8 ↘                      10.6 \*                      10.1 ←                      10.1 ↓                      10.6 \*  
 10.8 \*                      9.7 ↘                      10.7 \*                      10.4 \*                      10.3 \*  
 beste Teiler 26.0 (16.) 71.5 (18.) 92.1 (15.)  
 Trefferlage 0.44 mm links, 0.03 mm hoch  
 Streuwert 1.34, horizontal: 1.22, vertikal: 1.45

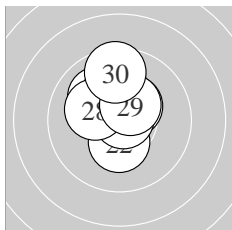

Serie 3:  
 10.0 ↘                      10.3 \*                      10.4 \*                      10.2 \*                      10.2 \*  
 10.8 \*                      10.3 \*                      10.2 \*                      10.4 \*                      9.6 ↑  
 beste Teiler 31.7 (26.) 136.0 (23.) 136.4 (29.)  
 Trefferlage 0.25 mm links, 1.18 mm hoch  
 Streuwert 1.12, horizontal: 0.88, vertikal: 1.31

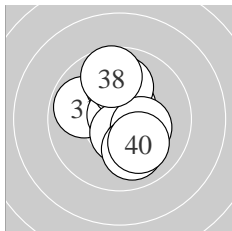

Serie 4:  
 9.9 ↖                      10.6 \*                      9.9 ↑                      10.8 \*                      10.0 ↑  
 10.6 \*                      10.3 \*                      9.7 ↑                      10.0 ↓                      10.1 ↘  
 beste Teiler 34.0 (34.) 99.2 (36.) 100.7 (32.)  
 Trefferlage 0.09 mm rechts, 0.45 mm hoch  
 Streuwert 1.54, horizontal: 1.18, vertikal: 1.84

Unterschrift des Schützen

Meyton Elektronik

Ergebnis: **393** (411.0)  
 Serien: 99 99 98 97  
 Zähler: 33 7 0 0 0 0 0 0 0 0  
 Innenzehner: 25  
 weiteste: 362 (33), 344 (36), 336 (32)  
 beste Teiler 19.3 (27.) 41.4 (7.) 42.2 (34.)  
 Trefferlage 0.11 mm rechts, 0.40 mm hoch  
 Streuwert 1.34, horizontal: 1.64, vertikal: 0.96

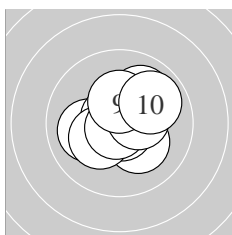
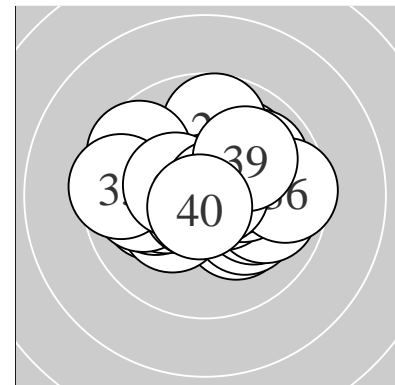

Serie 1:  
 10.0 ↗ 10.2 \* 10.0 ← 10.7 \* 10.8 \*  
 10.3 \* 10.8 \* 10.4 \* 10.3 \* 9.9 ↘  
 beste Teiler 41.4 (7.) 47.7 (5.) 66.2 (4.)  
 Trefferlage 0.20 mm rechts, 0.19 mm hoch  
 Streuwert 1.26, horizontal: 1.39, vertikal: 1.12

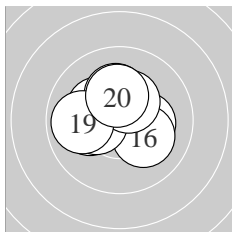

Serie 2:  
 10.7 \* 10.3 \* 10.2 \* 10.2 \* 10.1 ←  
 10.1 ↘ 10.3 \* 10.4 \* 9.9 ← 10.3 \*  
 beste Teiler 68.2 (11.) 146.6 (18.) 168.3 (17.)  
 Trefferlage 0.39 mm links, 0.42 mm hoch  
 Streuwert 1.30, horizontal: 1.55, vertikal: 0.98

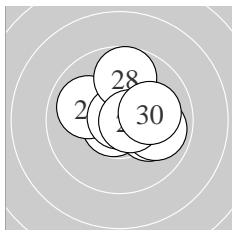

Serie 3:  
 10.6 \* 10.4 \* 10.7 \* 10.1 ↘ 9.9 →  
 10.0 ↖ 10.9 \* 9.7 ↑ 10.7 \* 10.1 →  
 beste Teiler 19.3 (27.) 56.8 (23.) 75.4 (29.)  
 Trefferlage 0.58 mm rechts, 0.45 mm hoch  
 Streuwert 1.28, horizontal: 1.44, vertikal: 1.11

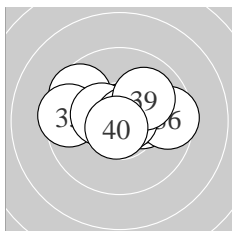

Serie 4:  
 10.3 \* 9.6 ↖ 9.5 ← 10.8 \* 10.4 \*  
 9.6 → 10.4 \* 10.7 \* 10.0 ↗ 10.7 \*  
 beste Teiler 42.2 (34.) 51.5 (38.) 52.3 (40.)  
 Trefferlage 0.08 mm rechts, 0.55 mm hoch  
 Streuwert 1.60, horizontal: 2.16, vertikal: 0.68

Unterschrift des Schützen

Meyton Elektronik