

Ergebnis: **389** (411.0)
 Serien: 98 97 97 97
 Zähler: 30 9 1 0 0 0 0 0 0 0
 Innenzehner: 26
 weiteste: 526 (11), 353 (34), 341 (16)
 beste Teiler 9.2 (22.) 15.6 (15.) 16.4 (19.)
 Trefferlage 0.20 mm links, 0.38 mm tief
 Streuwert 1.42, horizontal: 1.67, vertikal: 1.12

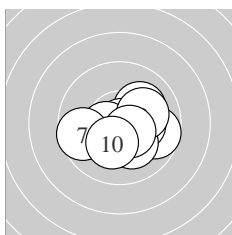

Serie 1:
 10.1 ↗ 9.7 → 10.9 * 10.3 * 10.2 *
 10.5 * 9.6 ← 10.1 → 10.5 * 10.2 *
 beste Teiler 19.7 (3.) 111.3 (9.) 120.8 (6.)
 Trefferlage 0.55 mm rechts, 0.43 mm tief
 Streuwert 1.44, horizontal: 1.80, vertikal: 0.95

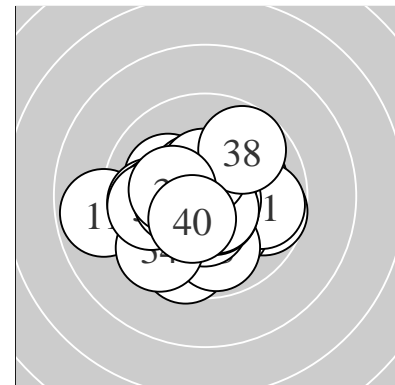
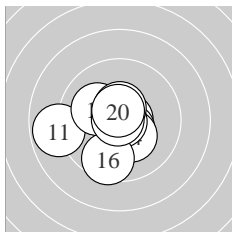

Serie 2:
 8.8 ← 10.7 * 10.5 * 10.3 * 10.9 *
 9.6 ↓ 10.1 ↖ 10.5 * 10.9 * 10.6 *
 beste Teiler 15.6 (15.) 16.4 (19.) 61.2 (12.)
 Trefferlage 0.59 mm links, 0.35 mm tief
 Streuwert 1.59, horizontal: 1.83, vertikal: 1.30

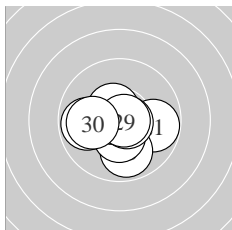

Serie 3:
 9.8 → 10.9 * 9.9 ↓ 9.8 ← 10.5 *
 10.6 * 10.4 * 10.7 * 10.8 * 10.0 ←
 beste Teiler 9.2 (22.) 37.3 (29.) 65.1 (28.)
 Trefferlage 0.14 mm links, 0.52 mm tief
 Streuwert 1.30, horizontal: 1.57, vertikal: 0.95

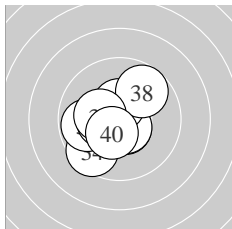

Serie 4:
 10.6 * 10.8 * 10.6 * 9.5 ↘ 10.5 *
 9.8 ← 10.4 * 9.7 ↗ 10.3 * 10.4 *
 beste Teiler 49.2 (32.) 87.4 (33.) 91.5 (31.)
 Trefferlage 0.65 mm links, 0.22 mm tief
 Streuwert 1.39, horizontal: 1.43, vertikal: 1.35

Unterschrift des Schützen

Meyton Elektronik

Ergebnis: **390** (408.2)
 Serien: 97 100 97 96
 Zähler: 30 10 0 0 0 0 0 0 0 0
 Innenzehner: 23
 weiteste: 458 (29), 379 (6), 375 (40)
 beste Teiler 11.1 (7.) 27.4 (1.) 50.2 (23.)
 Trefferlage 0.00 mm , 0.58 mm hoch
 Streuwert 1.46, horizontal: 1.51, vertikal: 1.41

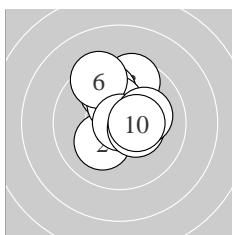
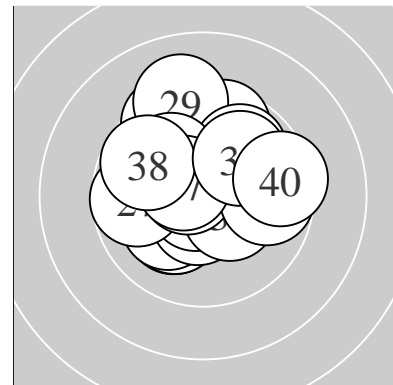

Serie 1:
 10.8 * 10.2 * 9.6 ↑ 9.9 ↑ 10.3 *
 9.4 ↘ 10.9 * 10.4 * 10.1 → 10.4 *
 beste Teiler 11.1 (7.) 27.4 (1.) 134.0 (10.)
 Trefferlage 0.13 mm rechts, 0.91 mm hoch
 Streuwert 1.46, horizontal: 1.22, vertikal: 1.67

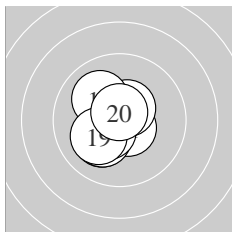

Serie 2:
 10.6 * 10.5 * 10.1 ↙ 10.5 * 10.2 *
 10.6 * 10.4 * 10.0 ↘ 10.1 ↙ 10.7 *
 beste Teiler 63.0 (20.) 84.7 (16.) 89.8 (11.)
 Trefferlage 0.75 mm links, 0.30 mm tief
 Streuwert 0.97, horizontal: 0.86, vertikal: 1.07

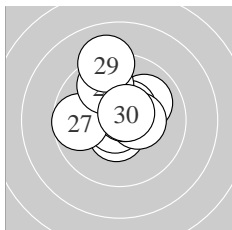

Serie 3:
 10.0 ↗ 10.5 * 10.8 * 10.5 * 10.4 *
 10.7 * 9.7 ← 9.8 ↘ 9.1 ↑ 10.6 *
 beste Teiler 50.2 (23.) 66.2 (26.) 76.4 (30.)
 Trefferlage 0.09 mm links, 0.89 mm hoch
 Streuwert 1.54, horizontal: 1.45, vertikal: 1.63

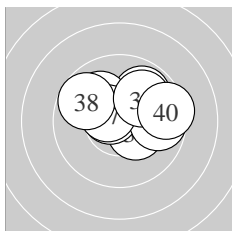

Serie 4:
 9.9 ↗ 10.2 * 10.0 ↘ 10.3 * 10.6 *
 9.7 → 10.5 * 9.7 ↘ 10.0 ↗ 9.5 →
 beste Teiler 84.2 (35.) 111.2 (37.) 151.7 (34.)
 Trefferlage 0.74 mm rechts, 0.84 mm hoch
 Streuwert 1.60, horizontal: 2.07, vertikal: 0.93

Unterschrift des Schützen

Meyton Elektronik

Ergebnis:	389	(408.7)
Serien:	98	97 97 97
Zähler:	29	11 0 0 0 0 0 0 0 0
Innenzehner:	21	
weiteste:	413 (14), 408 (5), 375 (31)	
beste Teiler	8.0 (32.) 20.5 (40.) 25.0 (33.)	
Trefferlage	0.05 mm links, 0.13 mm hoch	
Streuwert	1.55, horizontal: 1.88, vertikal: 1.13	

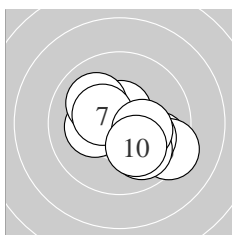
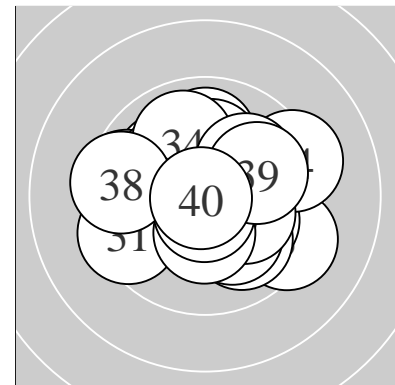

Serie 1:	9.7 ↘	10.2 *	10.6 *	10.1 ↖	9.3 ↘
	10.1 ↘	10.4 *	10.0 ↘	10.3 *	10.1 ↘
beste Teiler	89.5 (3.) 139.5 (7.) 173.3 (9.)				
Trefferlage	0.81 mm rechts, 0.57 mm tief				
Streuwert	1.60, horizontal: 1.90, vertikal: 1.23				

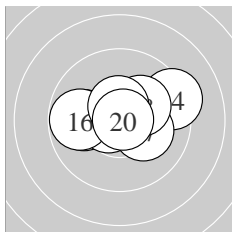

Serie 2:	10.4 *	9.9 ←	10.5 *	9.3 →	10.6 *
	9.8 ←	10.2 *	10.2 *	10.5 *	10.9 *
beste Teiler	25.3 (20.) 82.5 (15.) 102.3 (19.)				
Trefferlage	0.31 mm rechts, 0.34 mm hoch				
Streuwert	1.54, horizontal: 2.05, vertikal: 0.73				

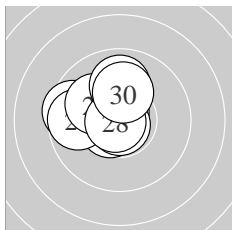

Serie 3:	10.7 *	10.6 *	10.8 *	9.5 ←	10.8 *
	9.7 ←	10.1 ↖	10.8 *	9.9 ↑	10.1 ↑
beste Teiler	33.2 (28.) 35.0 (23.) 35.0 (25.)				
Trefferlage	0.94 mm links, 0.60 mm hoch				
Streuwert	1.20, horizontal: 1.34, vertikal: 1.03				

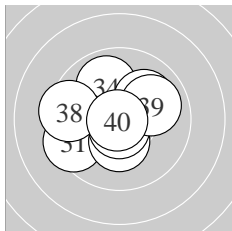

Serie 4:	9.5 ←	10.9 *	10.9 *	9.9 ↗	10.3 *
	10.0 ↗	10.7 *	9.5 ←	10.0 →	10.9 *
beste Teiler	8.0 (32.) 20.5 (40.) 25.0 (33.)				
Trefferlage	0.42 mm links, 0.15 mm hoch				
Streuwert	1.62, horizontal: 1.91, vertikal: 1.28				

Unterschrift des Schützen

Meyton Elektronik

Ergebnis:	393	(410.5)
Serien:	98	100 98 97
Zähler:	33	7 0 0 0 0 0 0 0 0
Innenzehner:	23	
weiteste:	389	(27), 357 (34), 298 (37)
beste Teiler	13.4	(9.) 18.3 (28.) 23.2 (12.)
Trefferlage	0.56 mm	rechts, 0.16 mm tief
Streuwert	1.34,	horizontal: 1.21, vertikal: 1.45

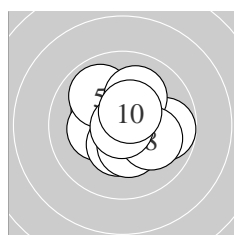
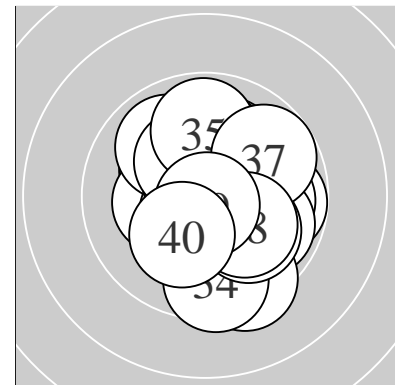

Serie 1:	10.2 *	10.3 *	10.4 *	9.8 →	9.9 ↖
	10.3 *	10.1 ↗	10.1 ↘	10.9 *	10.5 *
beste Teiler	13.4 (9.)	109.6 (10.)	140.9 (3.)		
Trefferlage	0.17 mm rechts, 0.16 mm hoch				
Streuwert	1.42, horizontal: 1.54, vertikal: 1.30				

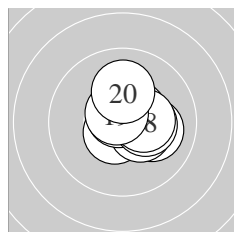

Serie 2:	10.5 *	10.9 *	10.1 ↘	10.6 *	10.4 *
	10.7 *	10.3 *	10.4 *	10.7 *	10.1 ↑
beste Teiler	23.2 (12.)	52.6 (16.)	75.7 (19.)		
Trefferlage	0.60 mm rechts, 0.17 mm hoch				
Streuwert	0.92, horizontal: 0.98, vertikal: 0.86				

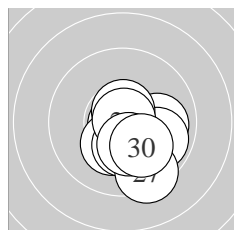

Serie 3:	10.8 *	10.0 →	10.3 *	9.9 ↘	10.6 *
	10.3 *	9.4 ↘	10.9 *	10.3 *	10.1 ↘
beste Teiler	18.3 (28.)	27.4 (21.)	77.1 (25.)		
Trefferlage	0.75 mm rechts, 1.05 mm tief				
Streuwert	1.18, horizontal: 1.14, vertikal: 1.23				

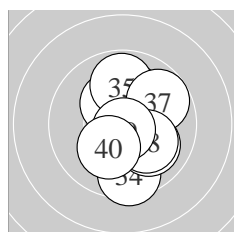

Serie 4:	10.3 *	10.1 ↗	10.1 ↗	9.5 ↓	9.8 ↑
	10.0 ↘	9.8 ↗	10.1 ↘	10.8 *	10.2 *
beste Teiler	39.8 (39.)	166.4 (31.)	191.9 (40.)		
Trefferlage	0.73 mm rechts, 0.05 mm hoch				
Streuwert	1.66, horizontal: 1.20, vertikal: 2.02				

Unterschrift des Schützen

Meyton Elektronik

Ergebnis: **393** (414.0)
 Serien: 98 98 99 98
 Zähler: 34 5 1 0 0 0 0 0 0 0
 Innenzehner: 30
 weiteste: 507 (7), 397 (23), 391 (38)
 beste Teiler 11.1 (29.) 34.0 (34.) 35.4 (22.)
 Trefferlage 0.35 mm rechts, 0.16 mm tief
 Streuwert 1.31, horizontal: 1.49, vertikal: 1.10

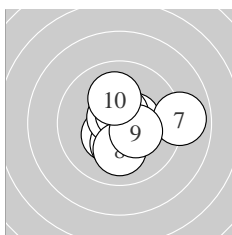
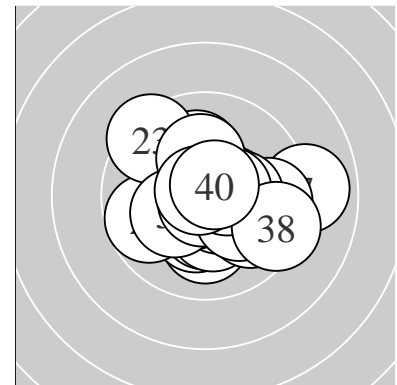

Serie 1:
 10.4 * 10.7 * 10.3 * 10.7 * 10.5 *
 10.6 * 8.9 → 10.1 ↓ 10.3 * 10.1 ↑
 beste Teiler 71.1 (2.) 72.1 (4.) 82.2 (6.)
 Trefferlage 0.55 mm rechts, 0.07 mm tief
 Streuwert 1.53, horizontal: 1.74, vertikal: 1.29

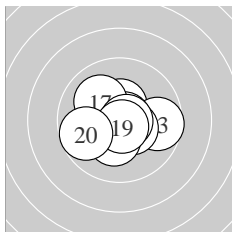

Serie 2:
 10.5 * 10.5 * 9.7 → 10.8 * 10.5 *
 10.3 * 10.1 ↖ 10.7 * 10.7 * 9.7 ←
 beste Teiler 40.4 (14.) 56.5 (18.) 57.5 (19.)
 Trefferlage 0.01 mm links, 0.23 mm tief
 Streuwert 1.33, horizontal: 1.59, vertikal: 1.00

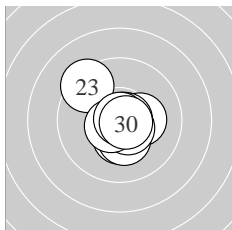

Serie 3:
 10.4 * 10.8 * 9.4 ↖ 10.3 * 10.3 *
 10.7 * 10.6 * 10.6 * 10.9 * 10.7 *
 beste Teiler 11.1 (29.) 35.4 (22.) 52.3 (26.)
 Trefferlage 0.07 mm rechts, 0.12 mm tief
 Streuwert 1.20, horizontal: 1.16, vertikal: 1.23

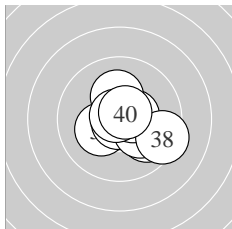

Serie 4:
 10.6 * 10.2 * 9.9 ↖ 10.8 * 10.1 ↖
 10.5 * 10.2 * 9.4 ↖ 10.8 * 10.7 *
 beste Teiler 34.0 (34.) 41.0 (39.) 73.1 (40.)
 Trefferlage 0.80 mm rechts, 0.21 mm tief
 Streuwert 1.28, horizontal: 1.48, vertikal: 1.04

Unterschrift des Schützen

Meyton Elektronik

Ergebnis: **390** (409.3)
 Serien: 96 97 97 100
 Zähler: 30 10 0 0 0 0 0 0 0 0
 Innenzehner: 22
 weiteste: 486 (16), 450 (20), 356 (17)
 beste Teiler 10.0 (23.) 11.4 (30.) 15.0 (27.)
 Trefferlage 0.06 mm rechts, 0.10 mm tief
 Streuwert 1.54, horizontal: 1.59, vertikal: 1.49

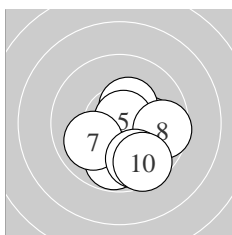
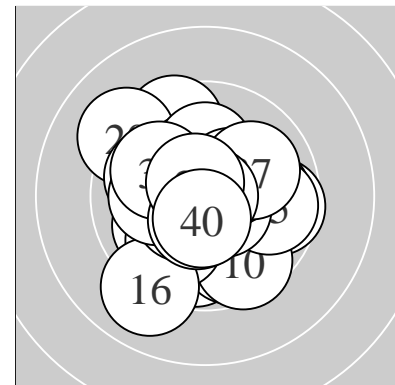

Serie 1:
 10.4 * 10.1 → 10.4 * 10.4 * 10.8 *
 9.8 ↓ 10.0 ↙ 9.6 → 9.8 ↓ 9.6 ↓
 beste Teiler 38.9 (5.) 140.0 (1.) 142.2 (4.)
 Trefferlage 0.88 mm rechts, 1.05 mm tief
 Streuwert 1.44, horizontal: 1.45, vertikal: 1.42

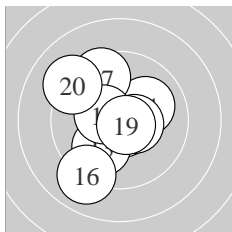

Serie 2:
 10.7 * 10.7 * 10.0 ↘ 10.1 ↗ 10.5 *
 9.0 ↘ 9.5 ↖ 10.4 * 10.7 * 9.2 ↖
 beste Teiler 61.4 (19.) 63.9 (12.) 74.3 (11.)
 Trefferlage 0.63 mm links, 0.08 mm hoch
 Streuwert 1.94, horizontal: 1.71, vertikal: 2.16

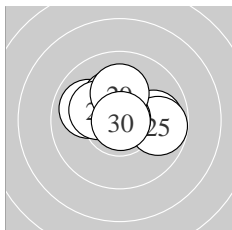

Serie 3:
 9.9 ↖ 10.6 * 10.9 * 9.9 → 9.8 →
 10.3 * 10.9 * 10.2 * 10.1 ↑ 10.9 *
 beste Teiler 10.0 (23.) 11.4 (30.) 15.0 (27.)
 Trefferlage 0.21 mm rechts, 0.51 mm hoch
 Streuwert 1.29, horizontal: 1.65, vertikal: 0.78

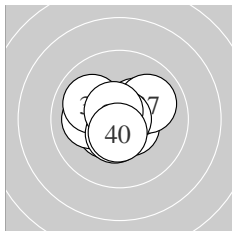

Serie 4:
 10.5 * 10.1 ← 10.0 ↖ 10.6 * 10.5 *
 10.4 * 10.0 ↗ 10.9 * 10.6 * 10.5 *
 beste Teiler 18.0 (38.) 76.4 (39.) 97.6 (34.)
 Trefferlage 0.19 mm links, 0.03 mm hoch
 Streuwert 1.14, horizontal: 1.36, vertikal: 0.88

Unterschrift des Schützen

Meyton Elektronik

Ergebnis: **386** (403.1)
 Serien: 96 95 98 97
 Zähler: 28 10 2 0 0 0 0 0 0
 Innenzehner: 21
 weiteste: 697 (40), 503 (14), 493 (7)
 beste Teiler 10.0 (16.) 28.4 (21.) 29.1 (35.)
 Trefferlage 0.57 mm rechts, 0.39 mm hoch
 Streuwert 1.80, horizontal: 1.62, vertikal: 1.96

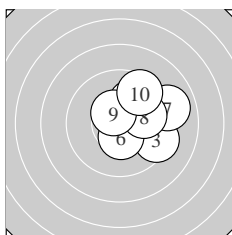
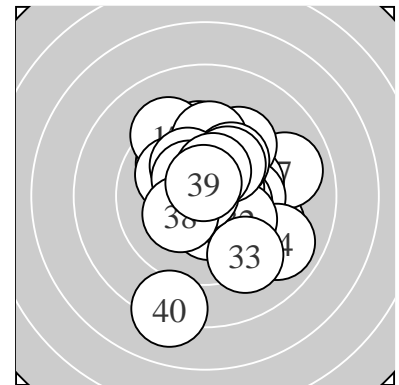

Serie 1:
 10.4 * 10.3 * 9.4 ↘ 10.0 ↗ 10.7 *
 10.4 * 9.0 → 9.9 → 10.5 * 9.5 ↗
 beste Teiler 54.0 (5.) 116.9 (9.) 133.7 (6.)
 Trefferlage 1.67 mm rechts, 0.57 mm hoch
 Streuwert 1.52, horizontal: 1.60, vertikal: 1.43

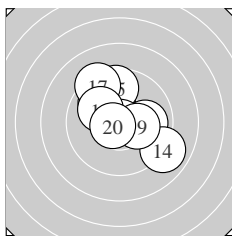

Serie 2:
 10.4 * 9.9 ↖ 10.0 → 8.9 ↘ 9.6 ↑
 10.9 * 9.3 ↖ 10.1 ↖ 10.2 * 10.6 *
 beste Teiler 10.0 (16.) 76.4 (20.) 132.0 (11.)
 Trefferlage 0.10 mm rechts, 0.77 mm hoch
 Streuwert 2.00, horizontal: 2.10, vertikal: 1.89

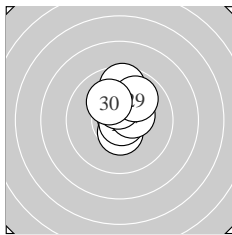

Serie 3:
 10.8 * 10.1 ↗ 10.5 * 9.6 ↑ 10.4 *
 10.8 * 10.4 * 10.4 * 9.9 ↗ 10.1 ↖
 beste Teiler 28.4 (21.) 33.4 (26.) 119.2 (23.)
 Trefferlage 0.35 mm rechts, 1.10 mm hoch
 Streuwert 1.06, horizontal: 0.73, vertikal: 1.30

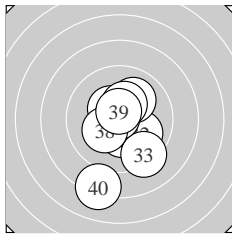

Serie 4:
 10.3 * 10.0 ↘ 9.3 ↘ 10.4 * 10.8 *
 10.0 ↗ 10.3 * 10.2 * 10.6 * 8.2 ↓
 beste Teiler 29.1 (35.) 76.5 (39.) 136.6 (34.)
 Trefferlage 0.16 mm rechts, 0.88 mm tief
 Streuwert 2.11, horizontal: 1.45, vertikal: 2.60

Unterschrift des Schützen

Meyton Elektronik

Ergebnis:	388	(406.0)
Serien:	99 98 96 95	
Zähler:	28 12 0 0 0 0 0 0 0	
Innenzehner:	21	
weiteste:	405 (13), 397 (21), 397 (34)	
beste Teiler	23.0 (31.) 27.7 (39.) 34.4 (27.)	
Trefferlage	0.54 mm rechts, 0.28 mm hoch	
Streuwert	1.55, horizontal: 1.42, vertikal: 1.68	

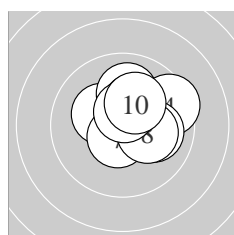
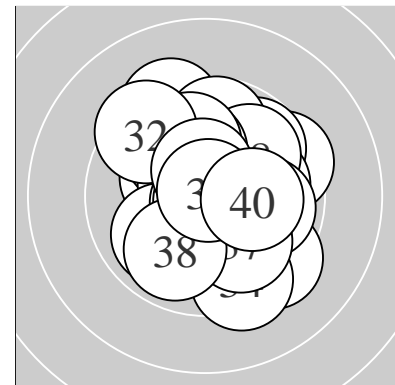

Serie 1:					
	10.4 *	10.3 *	10.0 ↑	9.5 ↘	10.3 *
	10.0 →	10.6 *	10.2 *	10.6 *	10.2 *
beste Teiler	92.8 (7.) 97.8 (9.) 143.5 (1.)				
Trefferlage	0.91 mm rechts, 0.66 mm hoch				
Streuwert	1.25, horizontal: 1.38, vertikal: 1.09				

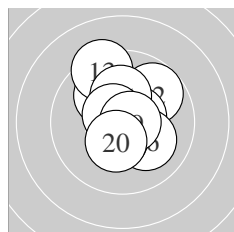

Serie 2:					
	10.0 ↖	9.8 ↗	9.3 ↖	10.5 *	10.2 *
	10.1 ↘	10.5 *	10.6 *	10.7 *	10.4 *
beste Teiler	56.0 (19.) 89.0 (18.) 103.6 (14.)				
Trefferlage	0.08 mm rechts, 0.67 mm hoch				
Streuwert	1.50, horizontal: 1.23, vertikal: 1.73				

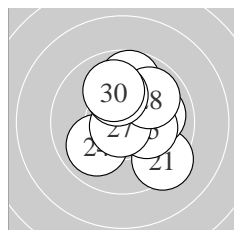

Serie 3:					
	9.4 ↘	10.0 →	10.6 *	9.9 ↙	10.2 *
	9.7 ↑	10.8 *	9.9 ↗	10.2 *	10.0 ↖
beste Teiler	34.4 (27.) 78.1 (23.) 181.6 (25.)				
Trefferlage	0.71 mm rechts, 0.43 mm hoch				
Streuwert	1.68, horizontal: 1.52, vertikal: 1.82				

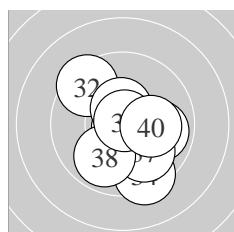

Serie 4:					
	10.9 *	9.4 ↖	10.3 *	9.4 ↘	9.9 →
	10.5 *	9.9 ↘	9.9 ↙	10.8 *	10.1 →
beste Teiler	23.0 (31.) 27.7 (39.) 114.5 (36.)				
Trefferlage	0.44 mm rechts, 0.63 mm tief				
Streuwert	1.72, horizontal: 1.59, vertikal: 1.85				

Unterschrift des Schützen

Meyton Elektronik