

Ergebnis:	392	(410.4)
Serien:	99 95 99 99	
Zähler:	32 8 0 0 0 0 0 0 0 0	
Innenzehner:	27	
weiteste:	363 (6), 353 (15), 305 (12)	
beste Teiler	36.7 (4.) 54.4 (36.) 79.6 (11.)	
Trefferlage	0.29 mm rechts, 0.52 mm tief	
Streuwert	1.29, horizontal: 1.36, vertikal: 1.22	

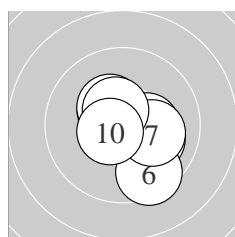

Serie 1:	10.1 ↘	10.4 *	10.1 ↘	10.8 *	10.3 *
	9.5 ↘	10.1 →	10.4 *	10.5 *	10.6 *
beste Teiler	36.7 (4.)	95.2 (10.)	111.8 (9.)		
Trefferlage	0.62 mm rechts, 0.35 mm tief				
Streuwert	1.30, horizontal: 1.30, vertikal: 1.30				

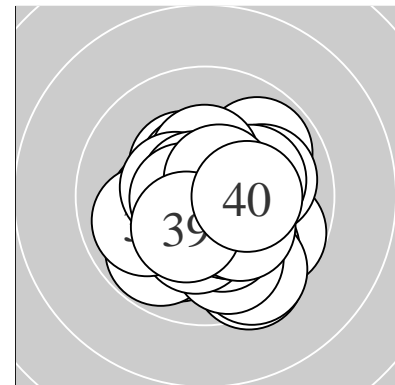
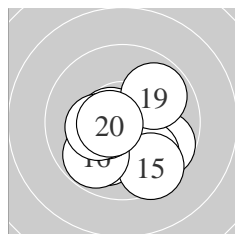

Serie 2:	10.6 *	9.7 ↘	9.9 ↘	10.0 ↙	9.5 ↘
	9.8 ↙	10.5 *	10.3 *	9.9 ↗	10.6 *
beste Teiler	79.6 (11.)	87.6 (20.)	121.8 (17.)		
Trefferlage	0.09 mm rechts, 0.97 mm tief				
Streuwert	1.60, horizontal: 1.75, vertikal: 1.44				

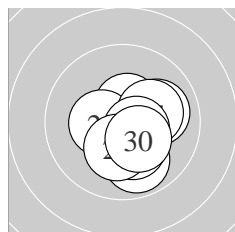

Serie 3:	9.9 ↘	10.6 *	10.5 *	10.4 *	10.2 *
	10.0 →	10.2 *	10.5 *	10.2 *	10.3 *
beste Teiler	94.3 (22.)	105.5 (28.)	109.4 (23.)		
Trefferlage	0.55 mm rechts, 0.57 mm tief				
Streuwert	1.16, horizontal: 1.15, vertikal: 1.18				

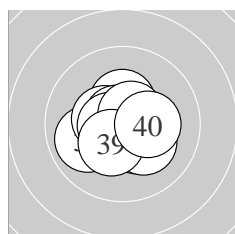

Serie 4:	10.4 *	9.9 ↙	10.2 *	10.4 *	10.5 *
	10.7 *	10.6 *	10.6 *	10.4 *	10.3 *
beste Teiler	54.4 (36.)	82.6 (37.)	86.4 (38.)		
Trefferlage	0.09 mm links, 0.18 mm tief				
Streuwert	1.11, horizontal: 1.26, vertikal: 0.93				

Unterschrift des Schützen

Meyton Elektronik

Ergebnis: **394** (408.2)
 Serien: 97 100 99 98
 Zähler: 35 4 1 0 0 0 0 0 0 0
 Innenzehner: 26
 weiteste: 640 (34), 379 (3), 324 (10)
 beste Teiler 52.2 (29.) 65.7 (14.) 88.5 (12.)
 Trefferlage 0.15 mm rechts, 0.07 mm tief
 Streuwert 1.50, horizontal: 1.66, vertikal: 1.33

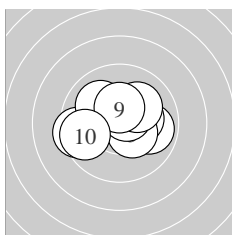
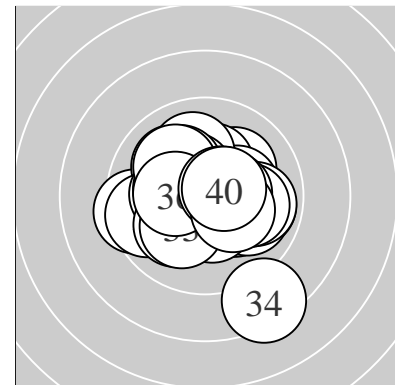

Serie 1:
 9.9 → 10.2 * 9.4 ← 10.3 * 10.4 *
 10.6 * 10.1 ↗ 10.0 ↖ 10.4 * 9.7 ←
 beste Teiler 89.8 (6.) 138.0 (9.) 140.8 (5.)
 Trefferlage 0.05 mm rechts, 0.33 mm hoch
 Streuwert 1.69, horizontal: 2.15, vertikal: 1.04

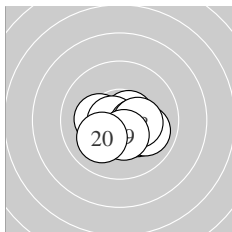

Serie 2:
 10.2 * 10.6 * 10.2 * 10.7 * 10.4 *
 10.2 * 10.0 ↘ 10.3 * 10.4 * 10.1 ↙
 beste Teiler 65.7 (14.) 88.5 (12.) 136.4 (19.)
 Trefferlage 0.25 mm rechts, 0.60 mm tief
 Streuwert 1.16, horizontal: 1.51, vertikal: 0.64

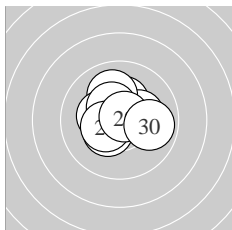

Serie 3:
 10.6 * 10.4 * 10.3 * 10.3 * 10.0 ↖
 10.3 * 10.4 * 10.4 * 10.7 * 9.9 →
 beste Teiler 52.2 (29.) 97.7 (21.) 134.3 (27.)
 Trefferlage 0.10 mm links, 0.38 mm hoch
 Streuwert 1.21, horizontal: 1.37, vertikal: 1.03

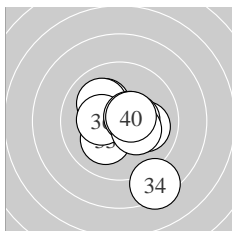

Serie 4:
 10.1 ↖ 10.1 ↖ 10.1 ↙ 8.4 ↘ 10.0 →
 10.3 * 10.4 * 10.6 * 10.3 * 10.5 *
 beste Teiler 91.7 (38.) 107.9 (40.) 133.5 (37.)
 Trefferlage 0.43 mm rechts, 0.43 mm tief
 Streuwert 1.90, horizontal: 1.73, vertikal: 2.05

Unterschrift des Schützen

Meyton Elektronik

Ergebnis:	389	(408.1)
Serien:	94 99 99 97	
Zähler:	29 11 0 0 0 0 0 0 0 0	
Innenzehner:	24	
weiteste:	414 (5), 392 (29), 372 (36)	
beste Teiler	21.0 (21.) 34.4 (39.) 38.2 (16.)	
Trefferlage	0.46 mm rechts, 0.29 mm hoch	
Streuwert	1.50, horizontal: 1.76, vertikal: 1.18	

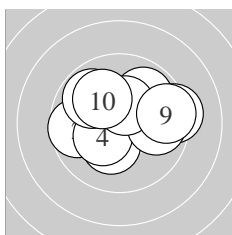
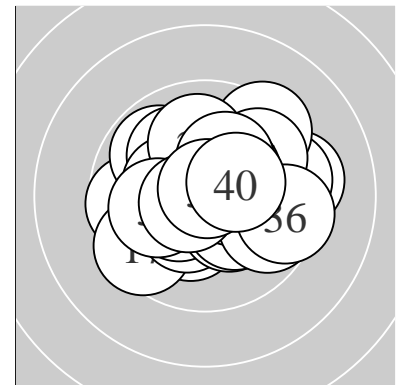

Serie 1:					
	10.3 *	9.7 ←	9.9 ↗	10.3 *	9.3 →
	9.8 →	10.4 *	9.8 ↘	9.5 →	10.1 ↖
beste Teiler	139.4 (7.)	159.8 (4.)	173.6 (1.)		
Trefferlage	0.41 mm rechts, 0.53 mm hoch				
Streuwert	1.99, horizontal: 2.51, vertikal: 1.27				

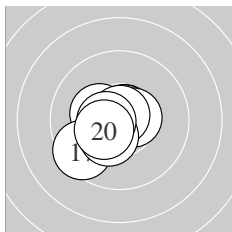

Serie 2:					
	10.7 *	10.3 *	10.7 *	10.8 *	10.6 *
	10.8 *	9.5 ↙	10.4 *	10.5 *	10.4 *
beste Teiler	38.2 (16.)	47.0 (14.)	55.2 (13.)		
Trefferlage	0.58 mm links, 0.27 mm tief				
Streuwert	1.01, horizontal: 1.11, vertikal: 0.90				

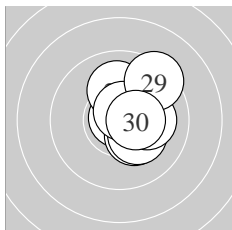

Serie 3:					
	10.9 *	10.4 *	10.3 *	10.3 *	10.3 *
	10.1 ↑	10.1 →	10.7 *	9.4 ↗	10.5 *
beste Teiler	21.0 (21.)	72.8 (28.)	122.0 (30.)		
Trefferlage	1.11 mm rechts, 0.42 mm hoch				
Streuwert	1.13, horizontal: 0.91, vertikal: 1.31				

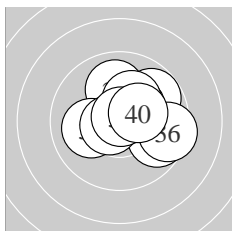

Serie 4:					
	10.0 ↑	9.7 →	10.1 ←	9.8 ↗	10.6 *
	9.5 →	10.3 *	10.2 *	10.8 *	10.3 *
beste Teiler	34.4 (39.)	82.0 (35.)	153.1 (40.)		
Trefferlage	0.92 mm rechts, 0.47 mm hoch				
Streuwert	1.51, horizontal: 1.76, vertikal: 1.20				

Unterschrift des Schützen

Ergebnis:	394	(412.1)
Serien:	96 99 99 100	
Zähler:	34 6 0 0 0 0 0 0 0 0	
Innenzehner:	31	
weiteste:	335 (3), 328 (10), 304 (14)	
beste Teiler	9.8 (40.) 32.8 (20.) 58.7 (24.)	
Trefferlage	0.20 mm rechts, 0.15 mm tief	
Streuwert	1.27, horizontal: 1.39, vertikal: 1.14	

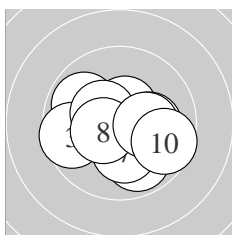
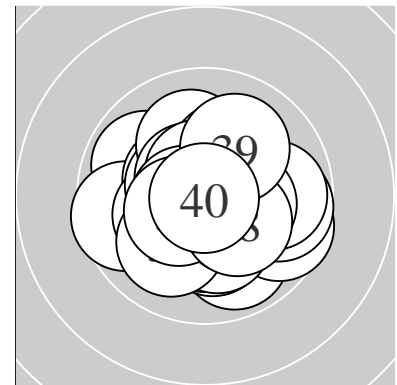

Serie 1:

9.9 ↘	9.9 ↖	9.6 ←	10.5 *	10.2 *
10.4 *	10.2 *	10.5 *	10.2 *	9.6 →
beste Teiler	103.4 (4.)	123.0 (8.)	132.7 (6.)	
Trefferlage	0.08 mm rechts, 0.41 mm tief			
Streuwert	1.67, horizontal: 2.03, vertikal: 1.20			

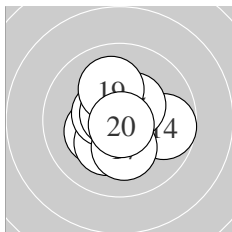

Serie 2:

10.3 *	10.3 *	10.2 *	9.7 →	10.4 *
10.5 *	10.2 *	10.7 *	10.1 ↑	10.8 *
beste Teiler	32.8 (20.)	67.2 (18.)	112.9 (16.)	
Trefferlage	0.07 mm links, 0.07 mm hoch			
Streuwert	1.30, horizontal: 1.29, vertikal: 1.30			

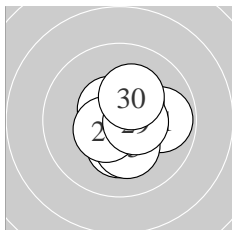

Serie 3:

9.8 →	10.3 *	10.4 *	10.7 *	10.2 *
10.7 *	10.6 *	10.5 *	10.5 *	10.2 *
beste Teiler	58.7 (24.)	69.1 (26.)	98.5 (27.)	
Trefferlage	0.54 mm rechts, 0.02 mm tief			
Streuwert	1.06, horizontal: 1.02, vertikal: 1.09			

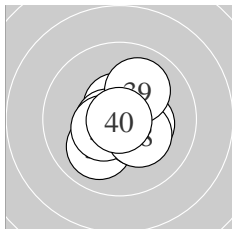

Serie 4:

10.5 *	10.0 ↙	10.6 *	10.6 *	10.3 *
10.5 *	10.3 *	10.3 *	10.0 ↗	10.9 *
beste Teiler	9.8 (40.)	83.1 (34.)	91.9 (33.)	
Trefferlage	0.28 mm rechts, 0.26 mm tief			
Streuwert	1.09, horizontal: 1.12, vertikal: 1.06			

Unterschrift des Schützen

Meyton Elektronik

Ergebnis:	395	(411.7)
Serien:	99 98 99 99	
Zähler:	35 5 0 0 0 0 0 0 0 0	
Innenzehner:	33	
weiteste:	379 (16), 354 (36), 315 (8)	
beste Teiler	11.4 (15.) 15.2 (39.) 63.2 (26.)	
Trefferlage	0.09 mm rechts, 0.31 mm hoch	
Streuwert	1.28, horizontal: 1.38, vertikal: 1.16	

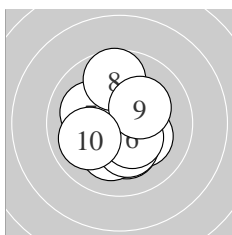
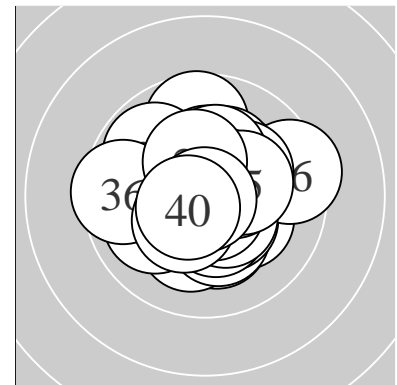

Serie 1:	10.2 *	10.4 *	10.2 *	10.2 *	10.3 *
	10.4 *	10.1 ↖	9.7 ↑	10.2 *	10.0 ↙
beste Teiler	135.9 (6.)	143.2 (2.)	173.6 (5.)		
Trefferlage	0.06 mm rechts, 0.45 mm tief				
Streuwert	1.48, horizontal: 1.33, vertikal: 1.62				

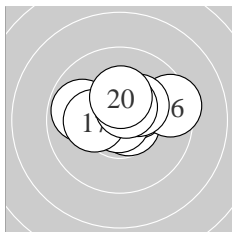

Serie 2:	10.5 *	9.8 ↖	10.7 *	10.3 *	10.9 *
	9.4 →	10.2 *	10.3 *	10.5 *	10.3 *
beste Teiler	11.4 (15.)	72.0 (13.)	105.9 (19.)		
Trefferlage	0.19 mm rechts, 0.65 mm hoch				
Streuwert	1.32, horizontal: 1.77, vertikal: 0.62				

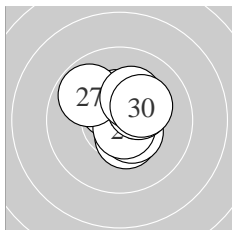

Serie 3:	10.4 *	10.5 *	10.5 *	10.3 *	10.4 *
	10.7 *	9.8 ↖	10.3 *	10.2 *	10.2 *
beste Teiler	63.2 (26.)	117.5 (22.)	123.0 (23.)		
Trefferlage	0.33 mm rechts, 0.62 mm hoch				
Streuwert	1.10, horizontal: 1.10, vertikal: 1.09				

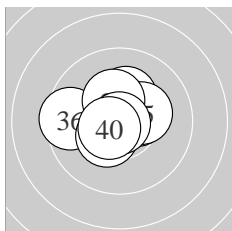

Serie 4:	10.5 *	10.4 *	10.3 *	10.6 *	10.3 *
	9.5 ←	10.3 *	10.4 *	10.9 *	10.6 *
beste Teiler	15.2 (39.)	89.3 (40.)	96.2 (34.)		
Trefferlage	0.18 mm links, 0.43 mm hoch				
Streuwert	1.18, horizontal: 1.42, vertikal: 0.86				

Unterschrift des Schützen

Ergebnis:	395	(409.5)
Serien:	99 98 99 99	
Zähler:	35 5 0 0 0 0 0 0 0 0	
Innenzehner:	24	
weiteste:	377 (20), 314 (26), 285 (14)	
beste Teiler	10.1 (39.) 44.2 (15.) 52.2 (33.)	
Trefferlage	0.09 mm rechts, 0.54 mm tief	
Streuwert	1.34, horizontal: 1.40, vertikal: 1.27	

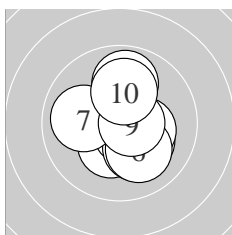
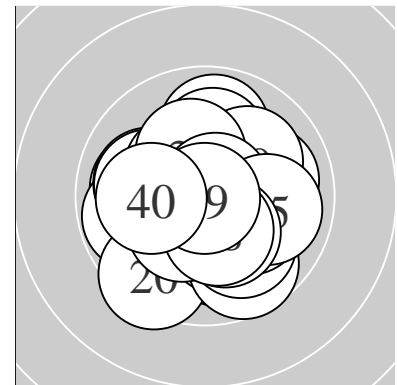

Serie 1:

10.2 *	10.3 *	10.7 *	10.3 *	10.2 *
10.1 ↘	10.0 ←	9.9 ↑	10.6 *	10.1 ↑
beste Teiler	74.8 (3.)	81.0 (9.)	156.5 (2.)	
Trefferlage	0.43 mm rechts, 0.20 mm tief			
Streuwert	1.38, horizontal: 1.20, vertikal: 1.54			

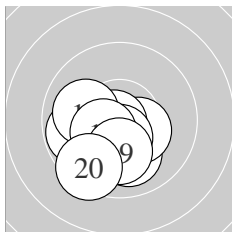

Serie 2:

10.3 *	10.0 ↓	10.4 *	9.8 ←	10.8 *
10.5 *	10.0 ←	10.4 *	10.1 ↓	9.4 ↙
beste Teiler	44.2 (15.)	118.0 (16.)	136.6 (18.)	
Trefferlage	0.82 mm links, 1.16 mm tief			
Streuwert	1.20, horizontal: 1.32, vertikal: 1.07			

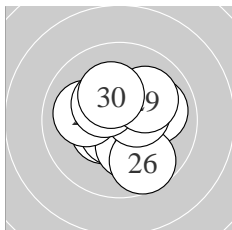

Serie 3:

10.4 *	10.0 →	10.6 *	10.2 *	10.0 ←
9.7 ↘	10.5 *	10.4 *	10.1 ↗	10.2 *
beste Teiler	91.3 (23.)	123.7 (27.)	127.0 (21.)	
Trefferlage	0.20 mm rechts, 0.02 mm tief			
Streuwert	1.46, horizontal: 1.49, vertikal: 1.43			

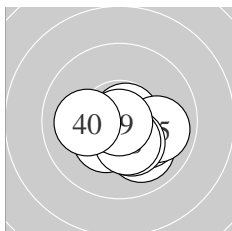

Serie 4:

10.5 *	10.0 ↘	10.7 *	10.2 *	9.9 →
10.3 *	10.3 *	10.4 *	10.9 *	10.1 ←
beste Teiler	10.1 (39.)	52.2 (33.)	117.3 (31.)	
Trefferlage	0.54 mm rechts, 0.77 mm tief			
Streuwert	1.08, horizontal: 1.35, vertikal: 0.72			

Unterschrift des Schützen

Meyton Elektronik

Ergebnis:	396	(412.3)
Serien:	99 99 99 99	
Zähler:	36 4 0 0 0 0 0 0 0 0	
Innenzehner:	28	
weiteste:	422 (15), 366 (3), 301 (39)	
beste Teiler	32.7 (37.) 36.0 (26.) 51.8 (21.)	
Trefferlage	0.29 mm rechts, 0.11 mm hoch	
Streuwert	1.28, horizontal: 1.57, vertikal: 0.90	

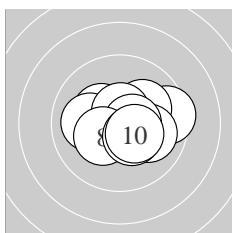
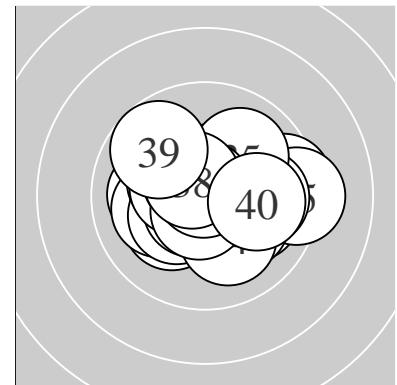

Serie 1:	10.3 *	10.0 ←	9.5 →	10.1 ↗	10.6 *
	10.0 →	10.6 *	10.3 *	10.4 *	10.4 *
beste Teiler	86.3 (5.)	97.0 (7.)	137.9 (9.)		
Trefferlage	0.57 mm rechts, 0.01 mm tief				
Streuwert	1.41, horizontal: 1.81, vertikal: 0.83				

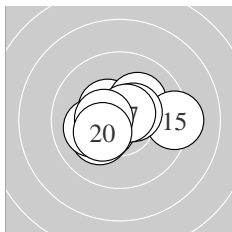

Serie 2:	10.4 *	10.2 *	10.2 *	10.4 *	9.3 →
	10.5 *	10.7 *	10.1 ←	10.5 *	10.3 *
beste Teiler	73.5 (17.)	119.2 (16.)	122.5 (19.)		
Trefferlage	0.09 mm links, 0.01 mm hoch				
Streuwert	1.48, horizontal: 1.91, vertikal: 0.85				

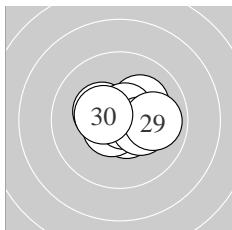

Serie 3:	10.7 *	10.6 *	10.2 *	10.3 *	10.6 *
	10.8 *	10.7 *	10.3 *	9.9 →	10.4 *
beste Teiler	36.0 (26.)	51.8 (21.)	73.4 (27.)		
Trefferlage	0.34 mm rechts, 0.14 mm hoch				
Streuwert	1.01, horizontal: 1.29, vertikal: 0.62				

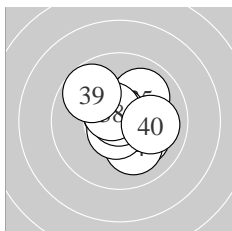

Serie 4:	10.6 *	10.4 *	10.1 ↘	10.1 ↘	10.0 ↗
	10.7 *	10.8 *	10.6 *	9.7 ↘	10.0 →
beste Teiler	32.7 (37.)	74.0 (36.)	95.2 (38.)		
Trefferlage	0.36 mm rechts, 0.29 mm hoch				
Streuwert	1.32, horizontal: 1.36, vertikal: 1.29				

Unterschrift des Schützen

Meyton Elektronik

Ergebnis:	395	(410.8)
Serien:	98	99 99 99
Zähler:	35	5 0 0 0 0 0 0 0 0
Innenzehner:	29	
weiteste:	364	(8), 339 (22), 307 (7)
beste Teiler	50.9	(11.) 54.4 (19.) 71.0 (14.)
Trefferlage	0.49	mm rechts, 0.06 mm hoch
Streuwert	1.28,	horizontal: 1.45, vertikal: 1.08

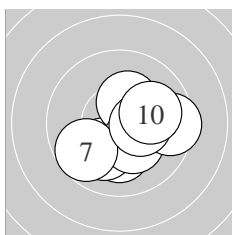
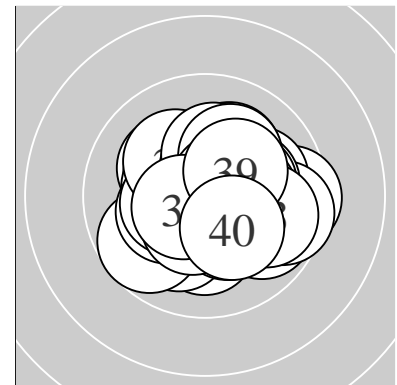

Serie 1:	10.5 *	10.1 ↓	10.0 →	10.1 ✓	10.3 *
	10.3 *	9.7 ↙	9.5 →	10.4 *	10.0 →
beste Teiler	109.0	(1.) 149.5 (9.)	160.4 (5.)		
Trefferlage	0.86	mm rechts, 0.57 mm tief			
Streuwert	1.51,	horizontal: 1.76, vertikal: 1.21			

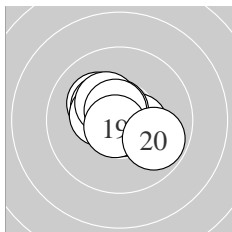

Serie 2:	10.8 *	10.4 *	10.2 *	10.7 *	10.3 *
	10.4 *	10.3 *	10.7 *	10.7 *	9.8 ↘
beste Teiler	50.9	(11.) 54.4 (19.)	71.0 (14.)		
Trefferlage	0.18	mm links, 0.27 mm hoch			
Streuwert	1.07,	horizontal: 1.26, vertikal: 0.84			

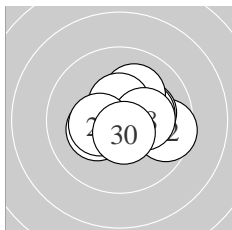

Serie 3:	10.5 *	9.6 →	10.3 *	10.2 *	10.2 *
	10.1 ↗	10.5 *	10.3 *	10.4 *	10.6 *
beste Teiler	96.1	(30.) 113.0 (27.)	114.5 (21.)		
Trefferlage	0.80	mm rechts, 0.17 mm hoch			
Streuwert	1.24,	horizontal: 1.52, vertikal: 0.86			

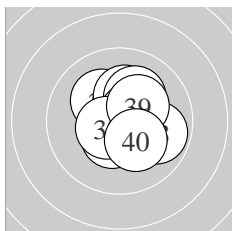

Serie 4:	10.2 *	10.5 *	9.9 →	10.2 *	10.4 *
	10.1 ↗	10.6 *	10.5 *	10.3 *	10.2 *
beste Teiler	90.2	(37.) 103.7 (38.)	125.6 (32.)		
Trefferlage	0.48	mm rechts, 0.39 mm hoch			
Streuwert	1.20,	horizontal: 1.17, vertikal: 1.23			

Unterschrift des Schützen