

Ergebnis: **381** (399.9)  
 Serien: 95 96 96 94  
 Zähler: 23 15 2 0 0 0 0 0 0  
 Innenzehner: 13  
 weiteste: 536 (6), 505 (18), 450 (8)  
 beste Teiler 35.2 (28.) 59.2 (5.) 61.0 (15.)  
 Trefferlage 0.30 mm links, 0.04 mm tief  
 Streuwert 1.89, horizontal: 2.27, vertikal: 1.41

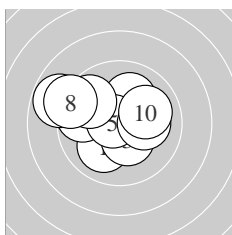

Serie 1:  
 10.0 ↙ 10.1 ↗ 10.4 \* 9.7 ← 10.7 \*  
 8.8 ← 9.7 ↘ 9.2 ↘ 10.1 → 10.0 →  
 beste Teiler 59.2 (5.) 148.9 (3.) 205.0 (9.)  
 Trefferlage 1.09 mm links, 0.60 mm hoch  
 Streuwert 2.05, horizontal: 2.55, vertikal: 1.38

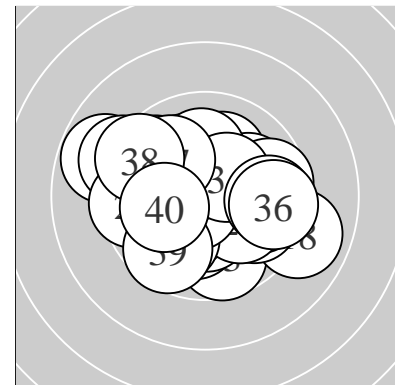
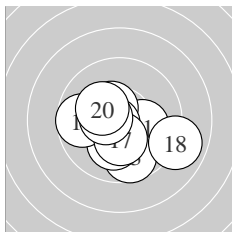

Serie 2:  
 10.2 \* 10.5 \* 9.7 ↓ 10.1 ↓ 10.7 \*  
 9.7 ← 10.3 \* 8.9 → 10.5 \* 10.3 \*  
 beste Teiler 61.0 (15.) 116.4 (19.) 123.1 (12.)  
 Trefferlage 0.00 mm , 0.71 mm tief  
 Streuwert 1.78, horizontal: 2.12, vertikal: 1.35

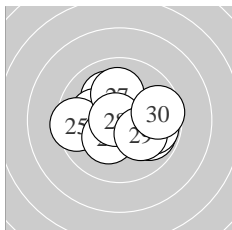

Serie 3:  
 10.1 ↘ 9.9 → 9.8 → 10.1 ← 9.5 ←  
 10.3 \* 10.1 ↑ 10.8 \* 10.1 ↘ 9.6 →  
 beste Teiler 35.2 (28.) 170.5 (26.) 203.1 (24.)  
 Trefferlage 0.21 mm rechts, 0.04 mm hoch  
 Streuwert 1.82, horizontal: 2.26, vertikal: 1.25

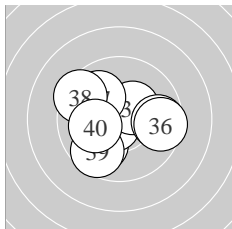

Serie 4:  
 9.9 ↙ 10.6 \* 10.7 \* 10.4 \* 9.7 →  
 9.6 → 9.9 ↘ 9.4 ↘ 9.7 ↙ 10.1 ←  
 beste Teiler 70.7 (33.) 89.5 (32.) 143.9 (34.)  
 Trefferlage 0.35 mm links, 0.10 mm tief  
 Streuwert 1.93, horizontal: 2.27, vertikal: 1.52

Unterschrift des Schützen

Meyton Elektronik

Ergebnis: **385** (400.6)  
 Serien: 94 99 96 96  
 Zähler: 27 11 2 0 0 0 0 0 0 0  
 Innenzehner: 20  
 weiteste: 657 (39), 574 (6), 467 (28)  
 beste Teiler 67.0 (22.) 70.6 (37.) 78.2 (24.)  
 Trefferlage 0.18 mm rechts, 0.43 mm hoch  
 Streuwert 1.91, horizontal: 2.27, vertikal: 1.46

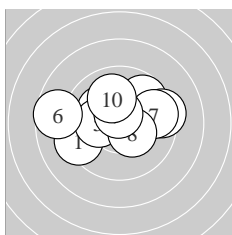
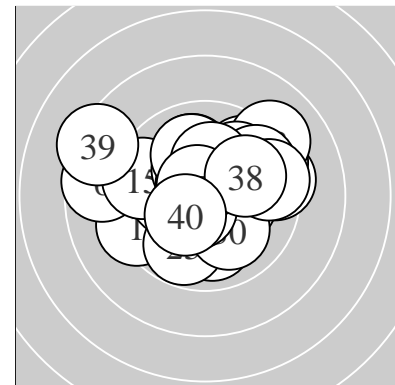

Serie 1:  
 9.3 ↙ 10.1 ↘ 9.7 ↗ 9.4 → 10.2 \*  
 8.7 ← 9.6 → 10.4 \* 10.6 \* 10.0 ↑  
 beste Teiler 86.7 (9.) 145.0 (8.) 192.0 (5.)  
 Trefferlage 0.36 mm links, 0.66 mm hoch  
 Streuwert 2.31, horizontal: 3.04, vertikal: 1.21

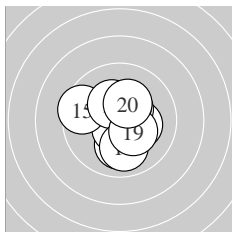

Serie 2:  
 10.0 ↓ 10.2 \* 10.6 \* 10.4 \* 9.5 ←  
 10.4 \* 10.3 \* 10.0 ↓ 10.3 \* 10.3 \*  
 beste Teiler 84.8 (13.) 130.3 (14.) 134.8 (16.)  
 Trefferlage 0.10 mm rechts, 0.08 mm tief  
 Streuwert 1.48, horizontal: 1.44, vertikal: 1.51

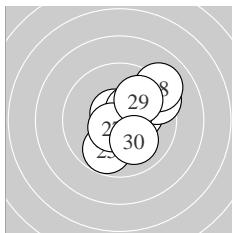

Serie 3:  
 10.2 \* 10.7 \* 9.4 ↗ 10.6 \* 9.8 ↘  
 10.4 \* 10.6 \* 9.1 ↗ 9.9 ↗ 10.1 ↘  
 beste Teiler 67.0 (22.) 78.2 (24.) 95.4 (27.)  
 Trefferlage 1.03 mm rechts, 0.29 mm hoch  
 Streuwert 1.71, horizontal: 1.65, vertikal: 1.76

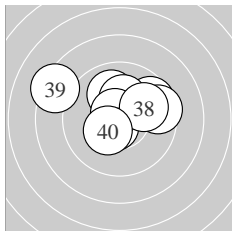

Serie 4:  
 9.6 ↗ 10.6 \* 9.5 → 10.6 \* 10.0 ↑  
 10.2 \* 10.7 \* 10.0 → 8.3 ↘ 10.3 \*  
 beste Teiler 70.6 (37.) 79.2 (32.) 83.2 (34.)  
 Trefferlage 0.03 mm links, 0.88 mm hoch  
 Streuwert 2.09, horizontal: 2.65, vertikal: 1.32

Unterschrift des Schützen

Meyton Elektronik

Ergebnis: **388** (406.7)  
 Serien: 98 98 95 97  
 Zähler: 28 12 0 0 0 0 0 0 0 0  
 Innenzehner: 22  
 weiteste: 481 (33), 451 (30), 346 (11)  
 beste Teiler 32.3 (22.) 56.0 (14.) 59.4 (1.)  
 Trefferlage 0.14 mm rechts, 0.29 mm hoch  
 Streuwert 1.56, horizontal: 1.73, vertikal: 1.36

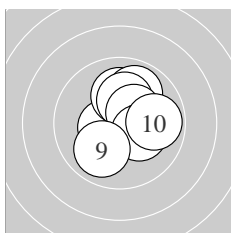
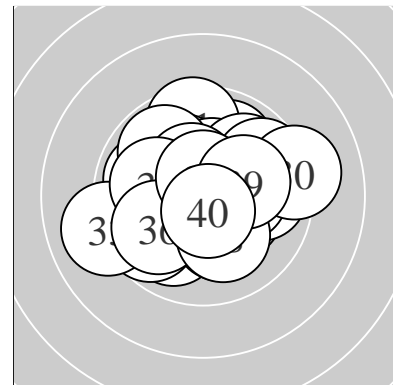

Serie 1:  
 10.7 \*                      10.5 \*                      10.1 ↑                      10.3 \*                      9.9 ↗  
 10.2 \*                      10.4 \*                      10.3 \*                      10.0 ↙                      9.9 →  
 beste Teiler 59.4 (1.) 115.1 (2.) 142.2 (7.)  
 Trefferlage 0.60 mm rechts, 0.42 mm hoch  
 Streuwert 1.35, horizontal: 1.28, vertikal: 1.43

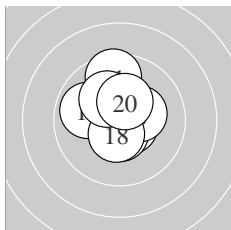

Serie 2:  
 9.6 ↑                      9.9 ←                      10.6 \*                      10.7 \*                      10.5 \*  
 10.4 \*                      10.3 \*                      10.5 \*                      10.2 \*                      10.3 \*  
 beste Teiler 56.0 (14.) 92.2 (13.) 105.1 (15.)  
 Trefferlage 0.11 mm links, 0.65 mm hoch  
 Streuwert 1.26, horizontal: 1.11, vertikal: 1.40

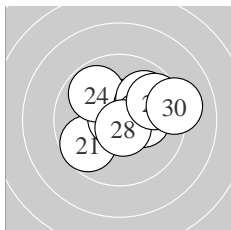

Serie 3:  
 9.7 ↙                      10.8 \*                      10.5 \*                      9.8 ↘                      10.1 ↗  
 9.9 ↗                      10.2 \*                      10.7 \*                      9.7 →                      9.1 →  
 beste Teiler 32.3 (22.) 68.9 (28.) 110.5 (23.)  
 Trefferlage 0.87 mm rechts, 0.62 mm hoch  
 Streuwert 1.71, horizontal: 2.09, vertikal: 1.20

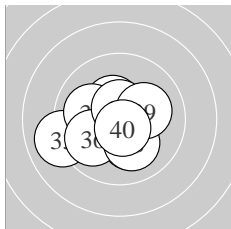

Serie 4:  
 10.2 \*                      9.9 ←                      9.0 ←                      10.4 \*                      10.0 ←  
 9.9 ↙                      10.6 \*                      10.1 ↓                      10.1 →                      10.7 \*  
 beste Teiler 75.8 (40.) 89.0 (37.) 135.6 (34.)  
 Trefferlage 0.78 mm links, 0.51 mm tief  
 Streuwert 1.64, horizontal: 1.98, vertikal: 1.23

Unterschrift des Schützen

Meyton Elektronik

Ergebnis: **383** (402.0)  
 Serien: 97 91 96 99  
 Zähler: 25 13 2 0 0 0 0 0 0 0  
 Innenzehner: 20  
 weiteste: 530 (14), 508 (29), 402 (10)  
 beste Teiler 27.0 (28.) 48.1 (39.) 63.2 (32.)  
 Trefferlage 0.22 mm rechts, 0.24 mm hoch  
 Streuwert 1.82, horizontal: 2.12, vertikal: 1.46

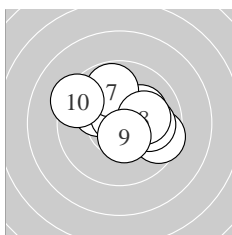
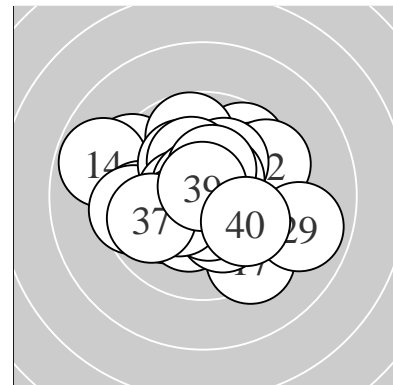

Serie 1:  
 10.2 \* 9.6 ↘ 10.0 → 10.6 \* 10.1 ↘  
 10.7 \* 9.8 ↑ 10.1 → 10.5 \* 9.3 ↘  
 beste Teiler 69.8 (6.) 87.0 (4.) 114.8 (9.)  
 Trefferlage 0.37 mm rechts, 0.64 mm hoch  
 Streuwert 1.70, horizontal: 2.08, vertikal: 1.21

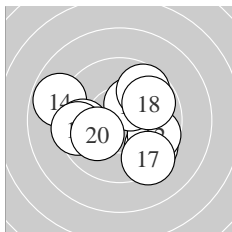

Serie 2:  
 9.6 ↘ 9.7 ↘ 10.3 \* 8.8 ↖ 9.7 ↗  
 9.7 ← 9.4 ↘ 9.8 ↗ 9.5 ← 10.1 ↖  
 beste Teiler 162.5 (13.) 219.5 (20.) 283.8 (18.)  
 Trefferlage 0.02 mm links, 0.20 mm tief  
 Streuwert 2.51, horizontal: 3.03, vertikal: 1.86

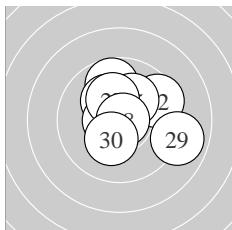

Serie 3:  
 10.3 \* 9.5 ↗ 9.7 ↑ 10.2 \* 10.2 \*  
 10.6 \* 10.2 \* 10.8 \* 8.9 → 10.3 \*  
 beste Teiler 27.0 (28.) 89.0 (26.) 159.6 (21.)  
 Trefferlage 0.61 mm rechts, 0.79 mm hoch  
 Streuwert 1.75, horizontal: 1.96, vertikal: 1.51

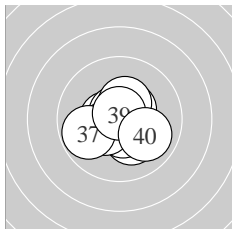

Serie 4:  
 10.5 \* 10.7 \* 10.2 \* 10.5 \* 10.5 \*  
 10.4 \* 9.8 ← 10.4 \* 10.8 \* 10.0 ↘  
 beste Teiler 48.1 (39.) 63.2 (32.) 106.0 (35.)  
 Trefferlage 0.05 mm links, 0.26 mm tief  
 Streuwert 1.19, horizontal: 1.34, vertikal: 1.03

Unterschrift des Schützen

Meyton Elektronik

Ergebnis: **385** (401.7)  
 Serien: 96 97 96 96  
 Zähler: 26 13 1 0 0 0 0 0 0 0  
 Innenzehner: 19  
 weiteste: 627 (32), 468 (6), 457 (9)  
 beste Teiler 18.3 (13.) 53.6 (39.) 61.1 (12.)  
 Trefferlage 0.04 mm rechts, 0.50 mm tief  
 Streuwert 1.85, horizontal: 2.21, vertikal: 1.39

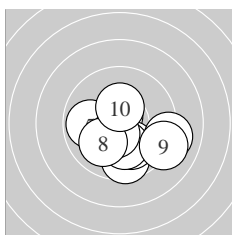
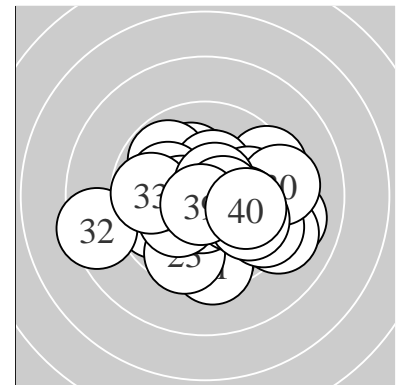

Serie 1:  
 10.7 \*                      9.6 ↓                      10.0 ↓                      10.1 ↓                      9.9 ←  
 9.1 →                      10.5 \*                      10.0 ↙                      9.1 →                      10.4 \*  
 beste Teiler 65.7 (1.) 104.7 (7.) 148.0 (10.)  
 Trefferlage 0.59 mm rechts, 1.14 mm tief  
 Streuwert 1.89, horizontal: 2.24, vertikal: 1.45

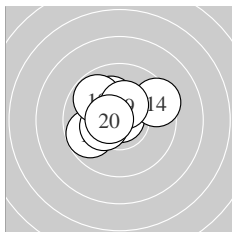

Serie 2:  
 10.2 \*                      10.7 \*                      10.9 \*                      9.4 →                      10.2 \*  
 9.8 ←                      10.3 \*                      9.8 ↘                      10.4 \*                      10.6 \*  
 beste Teiler 18.3 (13.) 61.1 (12.) 96.4 (20.)  
 Trefferlage 0.62 mm links, 0.62 mm hoch  
 Streuwert 1.43, horizontal: 1.70, vertikal: 1.09

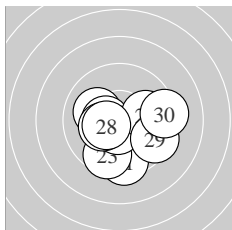

Serie 3:  
 9.4 ↓                      10.1 ↖                      9.6 ↓                      10.4 \*                      10.6 \*  
 10.3 \*                      10.0 →                      10.4 \*                      9.5 ↘                      9.3 →  
 beste Teiler 95.5 (25.) 129.0 (24.) 132.0 (28.)  
 Trefferlage 0.27 mm rechts, 0.88 mm tief  
 Streuwert 1.92, horizontal: 2.22, vertikal: 1.57

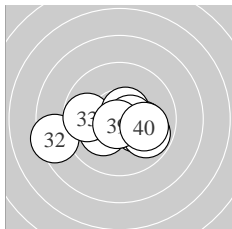

Serie 4:  
 10.2 \*                      8.4 ←                      9.8 ←                      10.2 \*                      10.1 →  
 10.6 \*                      9.8 →                      10.6 \*                      10.7 \*                      10.0 →  
 beste Teiler 53.6 (39.) 89.2 (36.) 100.0 (38.)  
 Trefferlage 0.08 mm links, 0.60 mm tief  
 Streuwert 1.99, horizontal: 2.72, vertikal: 0.75

Unterschrift des Schützen

Meyton Elektronik

Ergebnis: **387** (401.1)  
 Serien: 100 94 95 98  
 Zähler: 28 11 1 0 0 0 0 0 0  
 Innenzehner: 17  
 weiteste: 543 (19), 483 (25), 359 (23)  
 beste Teiler 118.4 (31.) 125.0 (3.) 127.1 (4.)  
 Trefferlage 0.12 mm rechts, 0.12 mm hoch  
 Streuwert 1.76, horizontal: 1.79, vertikal: 1.73

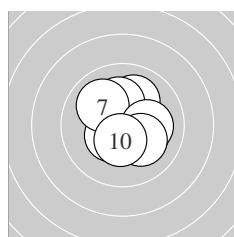
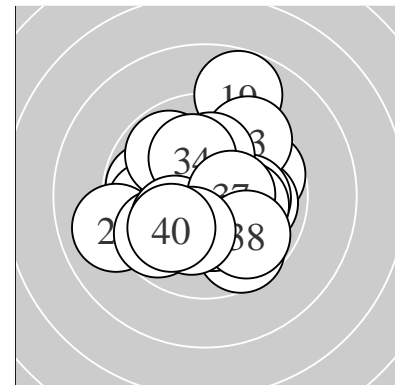

Serie 1:  
 10.1 ↗ 10.2 \* 10.5 \* 10.4 \* 10.2 \*  
 10.4 \* 10.0 ↘ 10.1 → 10.2 \* 10.4 \*  
 beste Teiler 125.0 (3.) 127.1 (4.) 128.4 (10.)  
 Trefferlage 0.33 mm rechts, 0.15 mm hoch  
 Streuwert 1.32, horizontal: 1.25, vertikal: 1.38

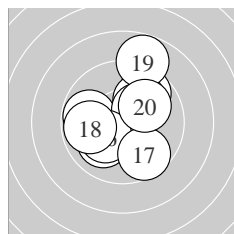

Serie 2:  
 9.7 ↗ 9.8 ← 10.0 ↙ 10.0 ↗ 10.3 \*  
 10.2 \* 9.6 ↘ 9.8 ← 8.8 ↑ 10.0 ↗  
 beste Teiler 169.7 (15.) 190.2 (16.) 231.9 (13.)  
 Trefferlage 0.13 mm rechts, 0.64 mm hoch  
 Streuwert 2.17, horizontal: 2.04, vertikal: 2.29

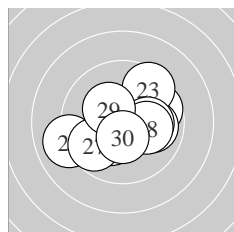

Serie 3:  
 9.7 → 9.9 → 9.5 ↗ 10.1 → 9.0 ←  
 10.3 \* 9.7 ↙ 10.1 → 10.3 \* 10.4 \*  
 beste Teiler 128.0 (30.) 163.3 (29.) 173.8 (26.)  
 Trefferlage 0.26 mm rechts, 0.21 mm tief  
 Streuwert 2.06, horizontal: 2.50, vertikal: 1.51

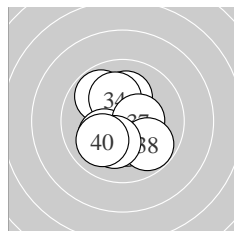

Serie 4:  
 10.5 \* 10.1 ↑ 9.8 ↘ 10.1 ↑ 10.3 \*  
 10.2 \* 10.4 \* 9.8 ↘ 10.2 \* 10.0 ↙  
 beste Teiler 118.4 (31.) 134.1 (37.) 164.2 (35.)  
 Trefferlage 0.23 mm links, 0.08 mm tief  
 Streuwert 1.54, horizontal: 1.32, vertikal: 1.74

Unterschrift des Schützen

Meyton Elektronik

Ergebnis: **389** (404.6)  
 Serien: 96 95 99 99  
 Zähler: 29 11 0 0 0 0 0 0 0 0  
 Innenzehner: 19  
 weiteste: 458 (5), 393 (12), 363 (4)  
 beste Teiler 51.8 (33.) 60.7 (9.) 79.2 (27.)  
 Trefferlage 0.01 mm rechts, 0.38 mm hoch  
 Streuwert 1.61, horizontal: 1.82, vertikal: 1.36

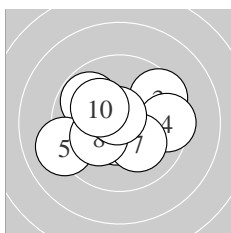
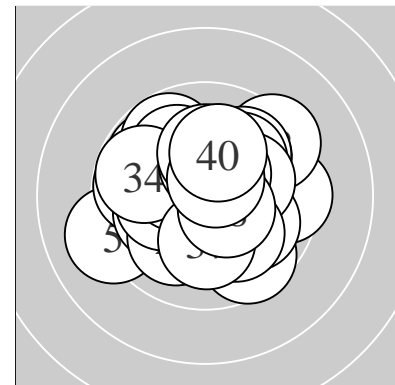

Serie 1:  
 10.4 \* 9.8 ↖ 9.5 ↗ 9.5 → 9.1 ←  
 10.6 \* 10.1 ↘ 10.2 \* 10.7 \* 10.2 \*  
 beste Teiler 60.7 (9.) 99.9 (6.) 137.3 (1.)  
 Trefferlage 0.07 mm links, 0.05 mm hoch  
 Streuwert 1.97, horizontal: 2.44, vertikal: 1.33

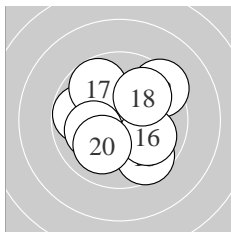

Serie 2:  
 10.3 \* 9.4 ↗ 9.6 ↘ 9.8 ← 10.4 \*  
 10.0 ↘ 9.8 ↖ 9.9 ↗ 10.1 ← 10.0 ↙  
 beste Teiler 148.3 (15.) 164.1 (11.) 214.3 (19.)  
 Trefferlage 0.07 mm rechts, 0.23 mm hoch  
 Streuwert 1.99, horizontal: 2.14, vertikal: 1.81

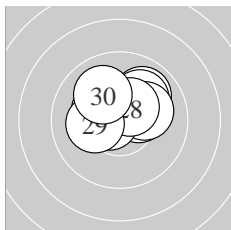

Serie 3:  
 10.3 \* 9.9 ↗ 10.5 \* 10.3 \* 10.1 ↗  
 10.1 → 10.6 \* 10.4 \* 10.2 \* 10.0 ↘  
 beste Teiler 79.2 (27.) 102.7 (23.) 128.8 (28.)  
 Trefferlage 0.10 mm rechts, 0.84 mm hoch  
 Streuwert 1.20, horizontal: 1.52, vertikal: 0.77

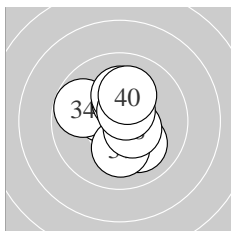

Serie 4:  
 10.1 ↘ 10.4 \* 10.7 \* 9.8 ↖ 10.3 \*  
 10.2 \* 10.1 ↓ 10.5 \* 10.6 \* 10.1 ↑  
 beste Teiler 51.8 (33.) 92.9 (39.) 115.2 (38.)  
 Trefferlage 0.06 mm links, 0.39 mm hoch  
 Streuwert 1.32, horizontal: 1.21, vertikal: 1.43

Unterschrift des Schützen

Meyton Elektronik

Ergebnis: **387** (405.2)  
 Serien: 96 98 98 95  
 Zähler: 28 11 1 0 0 0 0 0 0  
 Innenzehner: 18  
 weiteste: 529 (38), 411 (5), 325 (31)  
 beste Teiler 46.4 (29.) 67.4 (2.) 97.7 (30.)  
 Trefferlage 0.12 mm rechts, 0.00 mm  
 Streuwert 1.62, horizontal: 1.91, vertikal: 1.26

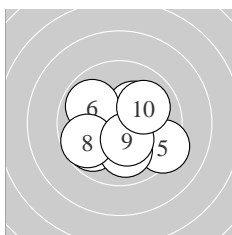
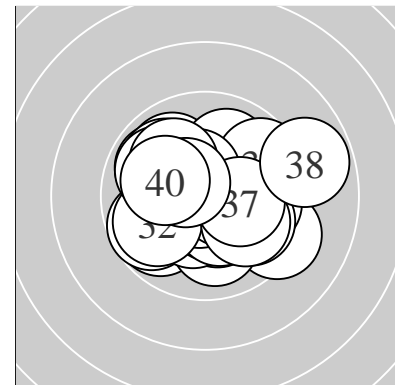

Serie 1:  
 9.8 ↙ 10.7 \* 10.0 ↘ 10.3 \* 9.3 ↘  
 9.9 ↖ 10.0 ↓ 9.7 ↙ 10.4 \* 10.0 ↗  
 beste Teiler 67.4 (2.) 148.9 (9.) 173.4 (4.)  
 Trefferlage 0.33 mm rechts, 0.61 mm tief  
 Streuwert 1.81, horizontal: 2.11, vertikal: 1.46

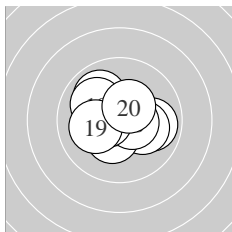

Serie 2:  
 10.4 \* 9.9 ↖ 9.9 → 10.1 → 10.3 \*  
 10.5 \* 10.5 \* 10.0 ↖ 10.1 ← 10.4 \*  
 beste Teiler 108.0 (16.) 118.2 (17.) 139.2 (20.)  
 Trefferlage 0.22 mm links, 0.04 mm hoch  
 Streuwert 1.41, horizontal: 1.69, vertikal: 1.07

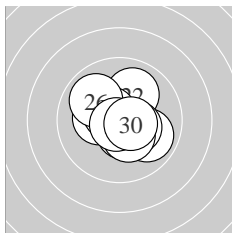

Serie 3:  
 10.5 \* 10.0 ↗ 10.3 \* 10.6 \* 9.9 ↘  
 9.9 ↖ 10.4 \* 10.4 \* 10.8 \* 10.6 \*  
 beste Teiler 46.4 (29.) 97.7 (30.) 100.6 (24.)  
 Trefferlage 0.18 mm rechts, 0.03 mm tief  
 Streuwert 1.28, horizontal: 1.37, vertikal: 1.18

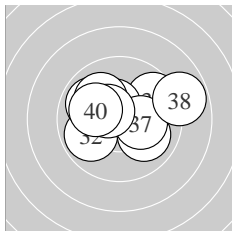

Serie 4:  
 9.7 ↗ 9.9 ↙ 10.5 \* 9.9 ↖ 10.0 ↘  
 10.0 ↘ 10.2 \* 8.8 → 10.5 \* 10.1 ↖  
 beste Teiler 118.7 (39.) 121.6 (33.) 179.3 (37.)  
 Trefferlage 0.19 mm rechts, 0.60 mm hoch  
 Streuwert 1.98, horizontal: 2.55, vertikal: 1.16

Unterschrift des Schützen

Meyton Elektronik