

Ergebnis:	<b>391</b>	(410.0)
Serien:	98	98 97 98
Zähler:	31	9 0 0 0 0 0 0 0 0
Innenzehner:	26	
weiteste:	444	(9), 403 (10), 368 (32)
beste Teiler	4.4	(37.) 35.4 (39.) 44.5 (33.)
Trefferlage	0.11 mm	rechts, 0.00 mm
Streuwert	1.47,	horizontal: 1.66, vertikal: 1.26

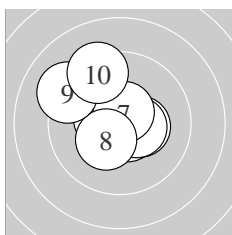

Serie 1:	10.6 *	10.8 *	10.3 *	10.4 *	10.5 *
	10.5 *	10.6 *	10.3 *	9.2 ↘	9.3 ↗
beste Teiler	49.0	(2.) 82.7	(1.) 87.3	(7.)	
Trefferlage	0.45 mm links, 0.50 mm hoch				
Streuwert	1.53, horizontal: 1.60, vertikal: 1.45				

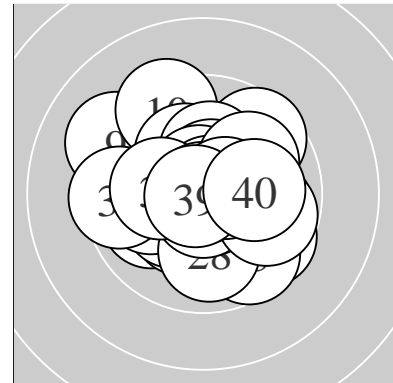
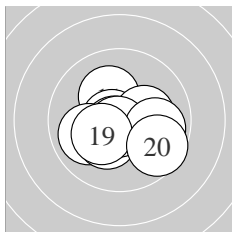

Serie 2:	10.2 *	10.7 *	10.7 *	10.0 ↙	10.3 *
	10.2 *	10.7 *	9.9 →	10.3 *	9.6 ↘
beste Teiler	51.5	(17.) 57.0	(12.) 61.8	(13.)	
Trefferlage	0.07 mm rechts, 0.48 mm tief				
Streuwert	1.40, horizontal: 1.71, vertikal: 1.00				

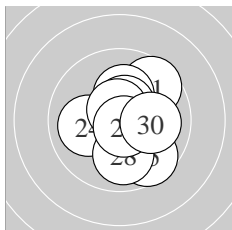

Serie 3:	9.6 ↗	10.2 *	10.5 *	10.0 ↙	9.6 ↘
	10.6 *	10.5 *	9.9 ↓	10.7 *	10.0 →
beste Teiler	56.3	(29.) 79.8	(26.) 110.0	(23.)	
Trefferlage	0.61 mm rechts, 0.11 mm tief				
Streuwert	1.54, horizontal: 1.38, vertikal: 1.68				

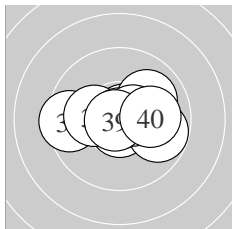

Serie 4:	10.7 *	9.5 ←	10.8 *	10.2 *	10.0 ↗
	9.8 →	10.9 *	10.6 *	10.8 *	10.0 →
beste Teiler	4.4	(37.) 35.4	(39.) 44.5	(33.)	
Trefferlage	0.24 mm rechts, 0.06 mm hoch				
Streuwert	1.45, horizontal: 1.96, vertikal: 0.61				

Unterschrift des Schützen

Meyton Elektronik

Ergebnis:	<b>380</b>	(400.2)
Serien:	96 95 96 93	
Zähler:	21 18 1 0 0 0 0 0 0 0	
Innenzehner:	16	
weiteste:	505 (33), 479 (21), 438 (31)	
beste Teiler	10.0 (29.) 36.0 (40.) 38.0 (3.)	
Trefferlage	0.93 mm rechts, 0.40 mm hoch	
Streuwert	1.79, horizontal: 1.93, vertikal: 1.64	

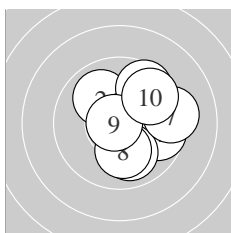
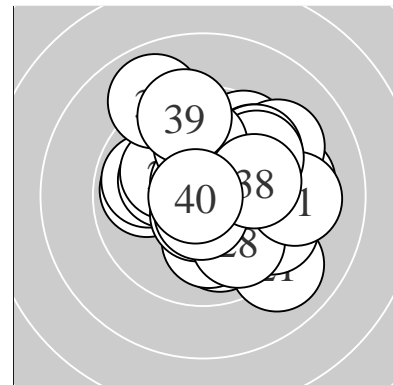

Serie 1:	10.5 *	10.0 ↖	10.8 *	9.7 →	9.6 ↗
	10.0 ↓	9.3 →	10.1 ↓	10.8 *	9.7 ↗
beste Teiler	38.0 (3.)	42.1 (9.)	108.1 (1.)		
Trefferlage	1.12 mm rechts, 0.36 mm hoch				
Streuwert	1.72, horizontal: 1.70, vertikal: 1.73				

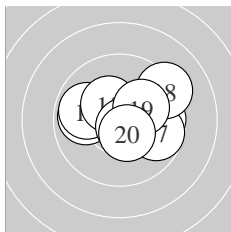

Serie 2:	9.9 ←	9.7 →	10.3 *	9.9 ←	10.3 *
	10.7 *	9.7 →	9.3 ↗	10.2 *	10.5 *
beste Teiler	61.2 (16.)	118.7 (20.)	151.9 (15.)		
Trefferlage	0.76 mm rechts, 0.28 mm hoch				
Streuwert	1.75, horizontal: 2.24, vertikal: 1.07				

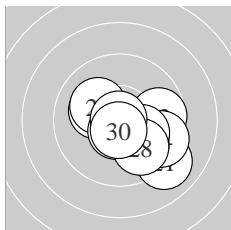

Serie 3:	9.0 ↘	9.7 →	10.2 *	9.5 ↘	10.1 ↖
	10.2 *	10.6 *	9.9 ↘	10.9 *	10.6 *
beste Teiler	10.0 (29.)	80.3 (30.)	91.3 (27.)		
Trefferlage	0.93 mm rechts, 0.73 mm tief				
Streuwert	1.71, horizontal: 2.00, vertikal: 1.35				

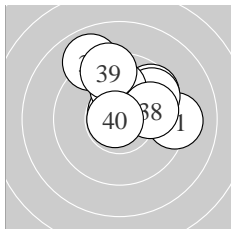

Serie 4:	9.2 →	9.7 ↗	8.9 ↖	10.7 *	10.2 *
	9.7 ↗	10.0 ↑	9.9 →	9.4 ↑	10.8 *
beste Teiler	36.0 (40.)	63.5 (34.)	190.1 (35.)		
Trefferlage	0.93 mm rechts, 1.70 mm hoch				
Streuwert	1.81, horizontal: 2.04, vertikal: 1.56				

Unterschrift des Schützen

Meyton Elektronik

Ergebnis: **384** (401.5)

Serien: 97 96 94 97

Zähler: 26 12 2 0 0 0 0 0 0 0

Innenzehner: 20

weiteste: 567 (24), 545 (11), 484 (22)

beste Teiler 37.5 (18.) 65.6 (35.) 69.3 (20.)

Trefferlage 0.53 mm rechts, 0.52 mm hoch

Streuwert 1.84, horizontal: 2.05, vertikal: 1.61

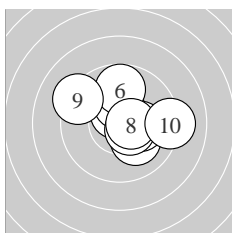
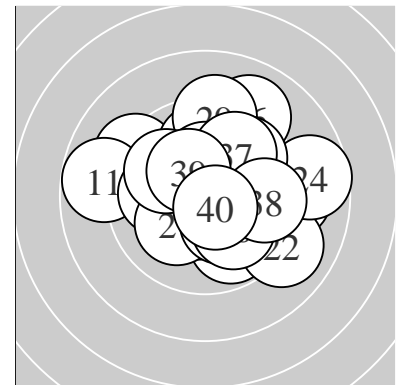

Serie 1:

10.1 ↘	10.3 *	10.6 *	10.2 *	10.3 *
9.8 ↑	10.5 *	10.5 *	9.2 ↖	9.2 →

beste Teiler 93.2 (3.) 102.1 (8.) 109.8 (7.)

Trefferlage 0.54 mm rechts, 0.67 mm hoch

Streuwert 1.77, horizontal: 2.06, vertikal: 1.40

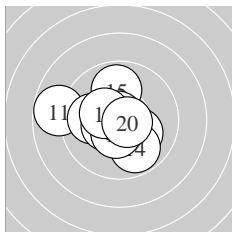

Serie 2:

8.8 ←	10.2 *	10.0 ←	9.8 ↘	9.9 ↑
10.4 *	10.5 *	10.8 *	10.4 *	10.7 *

beste Teiler 37.5 (18.) 69.3 (20.) 119.3 (17.)

Trefferlage 0.74 mm links, 0.08 mm tief

Streuwert 1.74, horizontal: 2.04, vertikal: 1.38

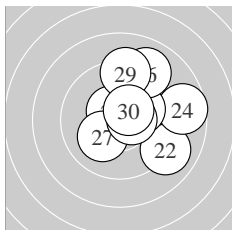

Serie 3:

9.9 ↗	9.0 ↘	10.5 *	8.7 →	10.1 ↗
9.0 ↗	10.1 ↙	10.5 *	9.3 ↑	10.5 *

beste Teiler 107.6 (23.) 108.1 (28.) 118.9 (30.)

Trefferlage 1.57 mm rechts, 1.00 mm hoch

Streuwert 2.13, horizontal: 2.10, vertikal: 2.15

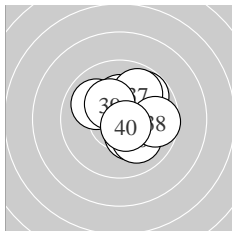

Serie 4:

10.0 ↖	10.3 *	10.3 *	9.8 ↗	10.7 *
10.1 ↘	9.9 ↗	9.7 →	10.3 *	10.6 *

beste Teiler 65.6 (35.) 82.8 (40.) 159.4 (39.)

Trefferlage 0.74 mm rechts, 0.50 mm hoch

Streuwert 1.47, horizontal: 1.50, vertikal: 1.43

Unterschrift des Schützen

Meyton Elektronik

Ergebnis: **381** (397.9)  
 Serien: 95 96 94 96  
 Zähler: 22 17 1 0 0 0 0 0 0 0  
 Innenzehner: 12  
 weiteste: 527 (30), 440 (23), 421 (26)  
 beste Teiler 21.2 (6.) 66.7 (3.) 71.5 (19.)  
 Trefferlage 0.55 mm rechts, 0.16 mm hoch  
 Streuwert 1.93, horizontal: 1.97, vertikal: 1.89

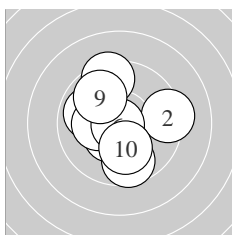
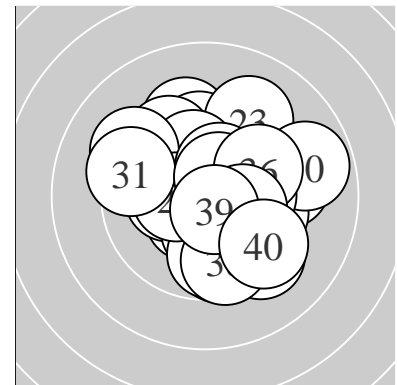

Serie 1:  
 10.4 \* 9.3 → 10.7 \* 9.9 ↖ 10.2 \*  
 10.9 \* 9.4 ↑ 9.7 ↓ 9.9 ↗ 10.1 ↓  
 beste Teiler 21.2 (6.) 66.7 (3.) 131.4 (1.)  
 Trefferlage 0.27 mm links, 0.03 mm hoch  
 Streuwert 1.92, horizontal: 1.84, vertikal: 1.99

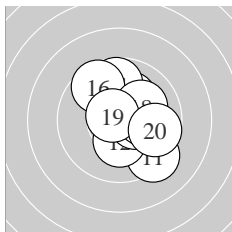

Serie 2:  
 9.3 ↘ 10.3 \* 10.1 ↗ 9.7 ↑ 10.4 \*  
 9.6 ↘ 10.1 → 10.1 ↗ 10.7 \* 9.7 →  
 beste Teiler 71.5 (19.) 133.6 (15.) 171.0 (12.)  
 Trefferlage 0.91 mm rechts, 0.35 mm hoch  
 Streuwert 1.75, horizontal: 1.57, vertikal: 1.92

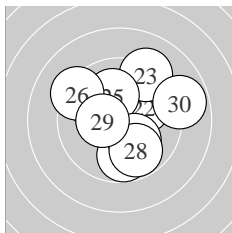

Serie 3:  
 9.8 ↓ 10.0 ↗ 9.2 ↗ 10.1 ↖ 10.1 ↑  
 9.3 ↖ 10.1 ↘ 9.8 ↘ 10.4 \* 8.8 →  
 beste Teiler 144.0 (29.) 210.2 (27.) 213.1 (24.)  
 Trefferlage 0.48 mm rechts, 0.47 mm hoch  
 Streuwert 2.34, horizontal: 2.46, vertikal: 2.22

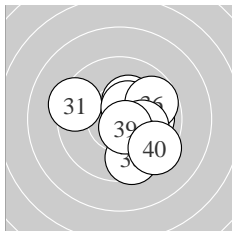

Serie 4:  
 9.4 ↖ 10.1 → 10.3 \* 10.5 \* 10.0 →  
 9.7 ↗ 10.2 \* 9.6 ↓ 10.6 \* 9.4 ↘  
 beste Teiler 84.0 (39.) 118.4 (34.) 162.3 (33.)  
 Trefferlage 1.11 mm rechts, 0.19 mm tief  
 Streuwert 1.78, horizontal: 1.93, vertikal: 1.61

Unterschrift des Schützen

Meyton Elektronik

Ergebnis: **391** (408.8)  
 Serien: 98 98 98 97  
 Zähler: 31 9 0 0 0 0 0 0 0 0  
 Innenzehner: 24  
 weiteste: 490 (20), 371 (37), 326 (33)  
 beste Teiler 35.6 (23.) 37.7 (40.) 39.0 (14.)  
 Trefferlage 0.06 mm links, 0.35 mm hoch  
 Streuwert 1.47, horizontal: 1.59, vertikal: 1.33

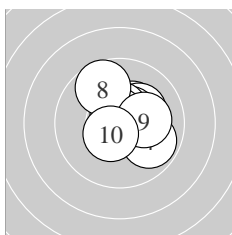
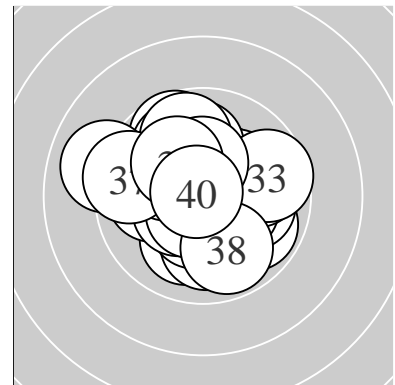

Serie 1:  
 10.3 \*                      10.2 \*                      10.8 \*                      9.9 ↘                      10.5 \*  
 10.5 \*                      10.7 \*                      9.7 ↖                      10.2 \*                      10.5 \*  
 beste Teiler 50.8 (3.) 63.7 (7.) 111.0 (6.)  
 Trefferlage 0.60 mm rechts, 0.54 mm hoch  
 Streuwert 1.18, horizontal: 1.18, vertikal: 1.18

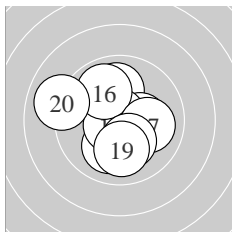

Serie 2:  
 10.0 ↑                      10.3 \*                      10.1 ↓                      10.8 \*                      10.6 \*  
 9.9 ↘                      10.0 →                      10.2 \*                      10.0 ↓                      9.0 ←  
 beste Teiler 39.0 (14.) 80.6 (15.) 165.0 (12.)  
 Trefferlage 0.30 mm links, 0.04 mm tief  
 Streuwert 1.80, horizontal: 1.89, vertikal: 1.71

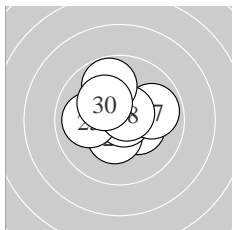

Serie 3:  
 10.3 \*                      10.4 \*                      10.8 \*                      10.4 \*                      10.0 ←  
 10.2 \*                      9.9 →                      10.6 \*                      9.8 ↗                      10.2 \*  
 beste Teiler 35.6 (23.) 80.6 (28.) 135.0 (22.)  
 Trefferlage 0.16 mm links, 0.63 mm hoch  
 Streuwert 1.32, horizontal: 1.45, vertikal: 1.16

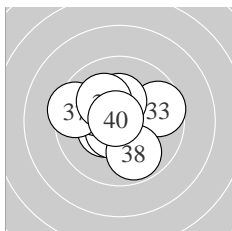

Serie 4:  
 10.8 \*                      10.4 \*                      9.6 →                      10.6 \*                      10.3 \*  
 10.1 ↖                      9.5 ←                      9.8 ↓                      10.1 ↖                      10.8 \*  
 beste Teiler 37.7 (40.) 50.4 (31.) 95.4 (34.)  
 Trefferlage 0.40 mm links, 0.27 mm hoch  
 Streuwert 1.56, horizontal: 1.79, vertikal: 1.29

Unterschrift des Schützen

Meyton Elektronik

Ergebnis: **384** (403.4)  
 Serien: 95 97 98 94  
 Zähler: 26 12 2 0 0 0 0 0 0 0  
 Innenzehner: 25  
 weiteste: 541 (31), 514 (36), 488 (2)  
 beste Teiler 11.1 (6.) 44.2 (19.) 50.0 (18.)  
 Trefferlage 0.11 mm rechts, 0.35 mm hoch  
 Streuwert 1.82, horizontal: 2.10, vertikal: 1.48

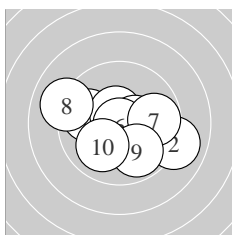
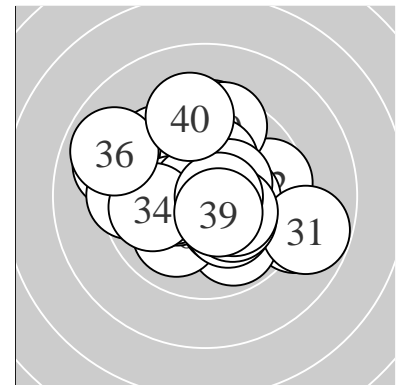

Serie 1:  
 10.7 \* 9.0 → 9.9 ← 10.6 \* 10.4 \*  
 10.9 \* 9.8 → 9.0 ← 9.9 ↘ 10.0 ↙  
 beste Teiler 11.1 (6.) 70.3 (1.) 96.7 (4.)  
 Trefferlage 0.20 mm rechts, 0.22 mm tief  
 Streuwert 2.08, horizontal: 2.65, vertikal: 1.30

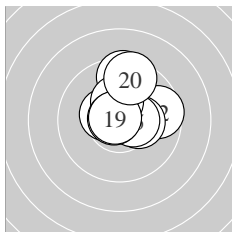

Serie 2:  
 10.4 \* 9.6 → 10.3 \* 9.5 ↑ 10.5 \*  
 10.4 \* 10.3 \* 10.8 \* 10.8 \* 9.5 ↑  
 beste Teiler 44.2 (19.) 50.0 (18.) 116.0 (15.)  
 Trefferlage 0.60 mm rechts, 1.07 mm hoch  
 Streuwert 1.35, horizontal: 1.28, vertikal: 1.42

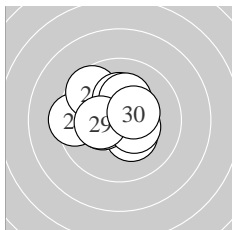

Serie 3:  
 10.3 \* 10.4 \* 10.4 \* 9.4 ← 9.6 ↖  
 10.4 \* 10.2 \* 10.2 \* 10.3 \* 10.4 \*  
 beste Teiler 134.7 (30.) 136.4 (26.) 143.0 (23.)  
 Trefferlage 0.53 mm links, 0.57 mm hoch  
 Streuwert 1.47, horizontal: 1.69, vertikal: 1.21

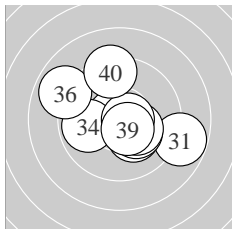

Serie 4:  
 8.8 → 10.7 \* 10.2 \* 9.9 ← 10.2 \*  
 8.9 ↖ 10.3 \* 10.7 \* 10.5 \* 9.3 ↑  
 beste Teiler 53.7 (32.) 70.1 (38.) 108.0 (39.)  
 Trefferlage 0.20 mm rechts, 0.00 mm  
 Streuwert 2.25, horizontal: 2.62, vertikal: 1.81

Unterschrift des Schützen

Meyton Elektronik

Ergebnis:	<b>385</b>	(403.9)
Serien:	96	97 95 97
Zähler:	25	15 0 0 0 0 0 0 0 0
Innenzehner:	18	
weiteste:	411	(30), 410 (7), 397 (35)
beste Teiler	28.3	(9.) 88.0 (1.) 90.2 (32.)
Trefferlage	0.19 mm	rechts, 0.31 mm hoch
Streuwert	1.65,	horizontal: 1.79, vertikal: 1.48

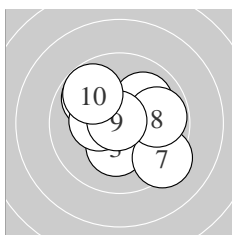
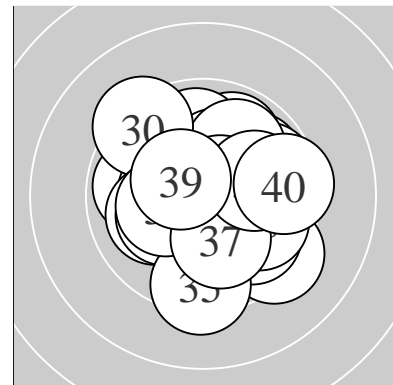

Serie 1:	10.6 *	10.6 *	10.3 *	10.0 ↗	9.8 ↘
	10.3 *	9.3 ↘	9.8 →	10.8 *	9.8 ↘
beste Teiler	28.3	(9.) 88.0 (1.)	92.0 (2.)		
Trefferlage	0.13 mm	rechts, 0.30 mm	hoch		
Streuwert	1.71,	horizontal: 1.91,	vertikal: 1.50		

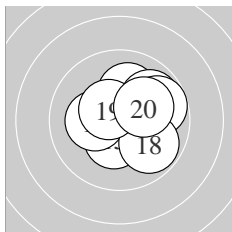

Serie 2:	10.5 *	10.5 *	10.1 ↑	9.9 ↗	10.4 *
	10.2 *	9.8 →	9.8 ↘	10.5 *	10.1 →
beste Teiler	107.7	(11.) 113.1 (19.)	118.6 (12.)		
Trefferlage	0.62 mm	rechts, 0.40 mm	hoch		
Streuwert	1.43,	horizontal: 1.61,	vertikal: 1.22		

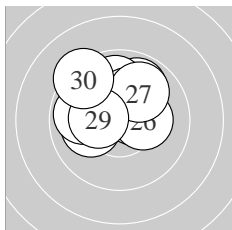

Serie 3:	9.9 ↗	9.9 ↑	10.1 ←	10.2 *	10.5 *
	10.3 *	9.9 ↗	9.9 ←	10.3 *	9.3 ↘
beste Teiler	108.8	(25.) 158.7 (29.)	175.0 (26.)		
Trefferlage	0.33 mm	links, 1.23 mm	hoch		
Streuwert	1.55,	horizontal: 1.79,	vertikal: 1.27		

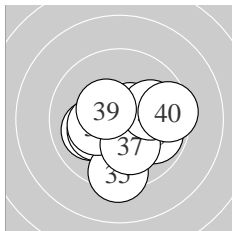

Serie 4:	10.0 ←	10.6 *	9.9 ↘	10.2 *	9.4 ↓
	10.3 *	10.1 ↘	10.0 →	10.5 *	9.5 →
beste Teiler	90.2	(32.) 124.4 (39.)	173.2 (36.)		
Trefferlage	0.34 mm	rechts, 0.67 mm	tief		
Streuwert	1.75,	horizontal: 2.00,	vertikal: 1.46		

Unterschrift des Schützen

Meyton Elektronik

Ergebnis: **403.6** (388)  
 Serien: 102.0 100.2 101.2 100.2  
 Zähler: 28 12 0 0 0 0 0 0 0 0  
 Innenzehner: 18  
 weiteste: 438 (21), 414 (11), 376 (40)  
 beste Teiler 22.4 (3.) 65.8 (30.) 72.0 (5.)  
 Trefferlage 0.50 mm rechts, 0.42 mm hoch  
 Streuwert 1.63, horizontal: 1.87, vertikal: 1.36

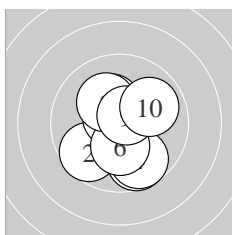
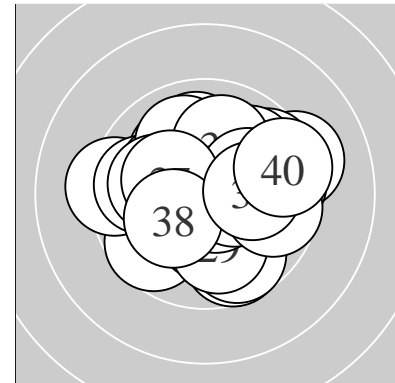

Serie 1:  
 9.7 ↘                      9.7 ↙                      10.9 \*                      9.7 ↘                      10.7 \*  
 10.3 \*                      10.3 \*                      10.2 \*                      10.6 \*                      9.9 ↗  
 beste Teiler 22.4 (3.) 72.0 (5.) 78.6 (9.)  
 Trefferlage 0.08 mm rechts, 0.43 mm tief  
 Streuwert 1.58, horizontal: 1.35, vertikal: 1.78

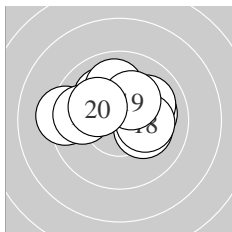

Serie 2:  
 9.3 ←                      10.1 ↖                      9.8 ←                      10.2 \*                      10.0 ↑  
 10.1 →                      10.0 ↗                      10.2 \*                      10.3 \*                      10.2 \*  
 beste Teiler 175.2 (19.) 191.1 (14.) 194.6 (20.)  
 Trefferlage 0.15 mm links, 0.82 mm hoch  
 Streuwert 1.73, horizontal: 2.26, vertikal: 0.93

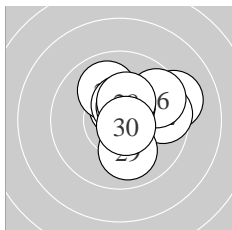

Serie 3:  
 9.2 →                      9.6 →                      10.6 \*                      10.0 ↖                      10.5 \*  
 9.7 ↗                      10.5 \*                      10.4 \*                      10.0 ↓                      10.7 \*  
 beste Teiler 65.8 (30.) 95.1 (23.) 112.8 (27.)  
 Trefferlage 1.13 mm rechts, 0.77 mm hoch  
 Streuwert 1.49, horizontal: 1.66, vertikal: 1.30

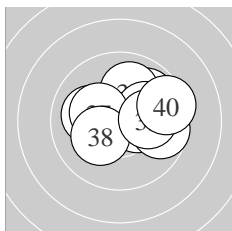

Serie 4:  
 9.9 ↗                      10.0 ↑                      10.1 ←                      10.4 \*                      9.7 →  
 10.1 →                      10.3 \*                      10.2 \*                      10.1 →                      9.4 →  
 beste Teiler 134.9 (34.) 170.8 (37.) 184.0 (38.)  
 Trefferlage 0.96 mm rechts, 0.53 mm hoch  
 Streuwert 1.62, horizontal: 2.04, vertikal: 1.04

Unterschrift des Schützen

Meyton Elektronik